

# Marioneta

Autor: Carlos González Santamaría

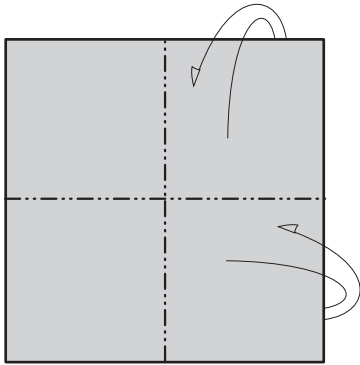

1. Tamaño del papel 20x20 cm.

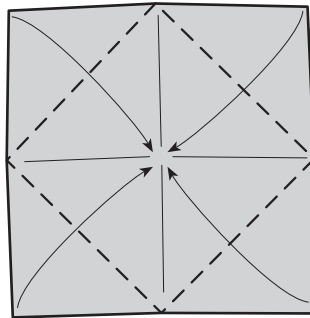

2.

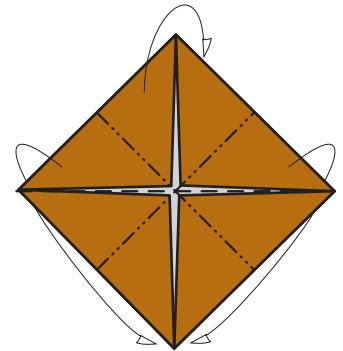

3.

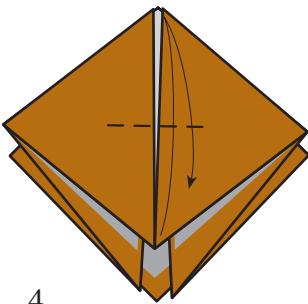

4.

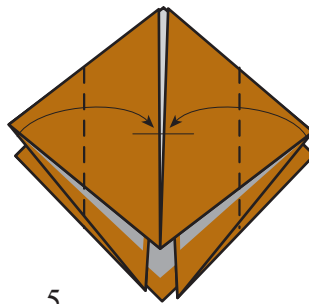

5.

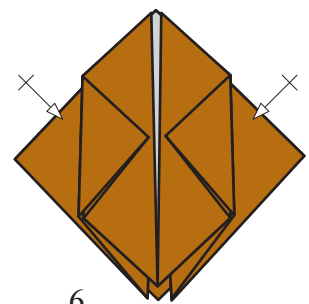

6.

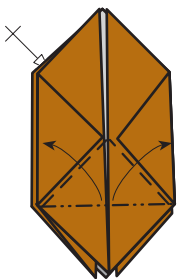

7.

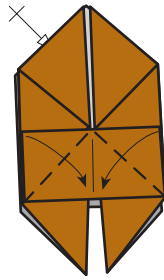

8.

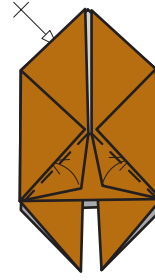

9.

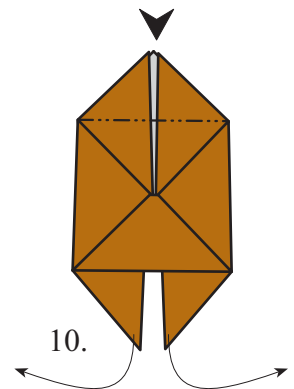

10.

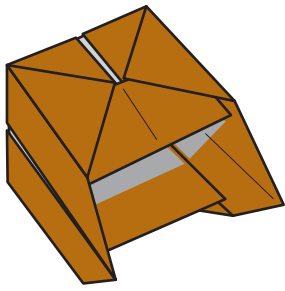

11. Este es el modulo básico.

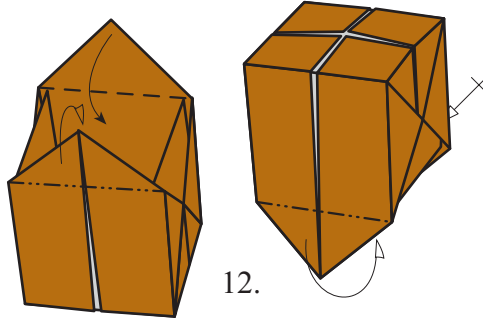

12.

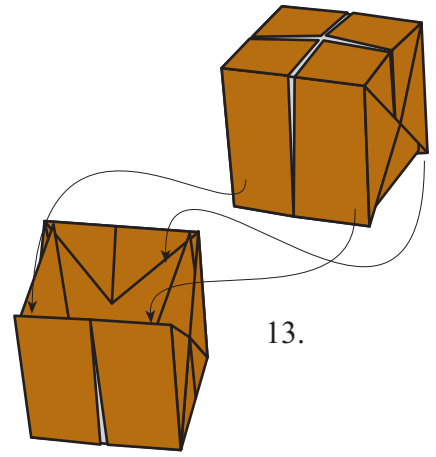

13.

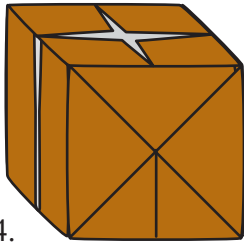

14.

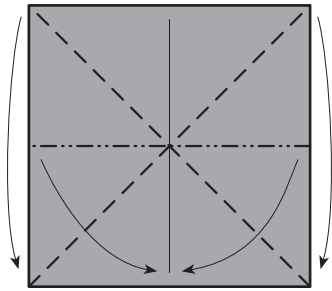

15.

● Negro  
○ Blanco

■ 10 cm  
□ 10 cm

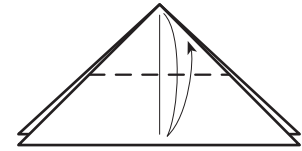

16.

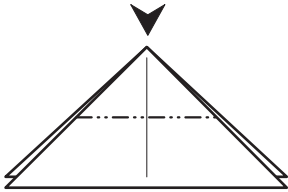

17.

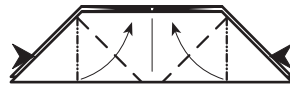

18.



19.

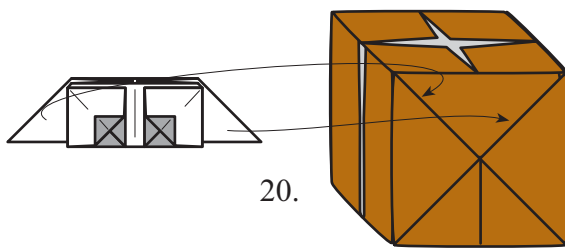

20.

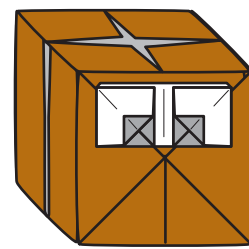

21.

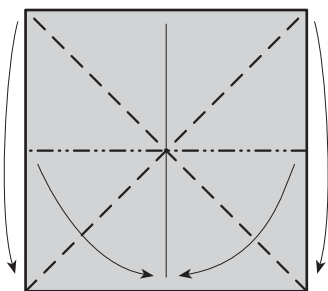

22.



■ 5 cm  
□ 5 cm

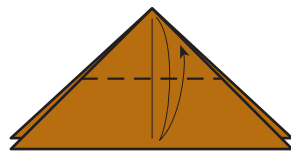

23.

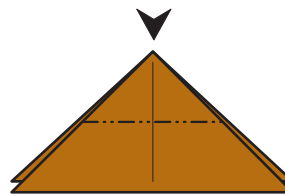

24.

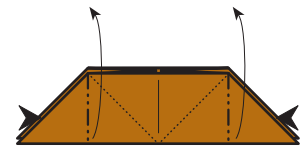

25.

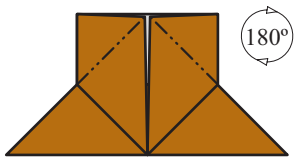

26.

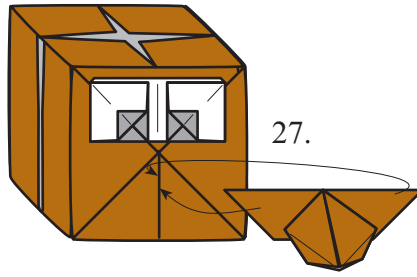

27.

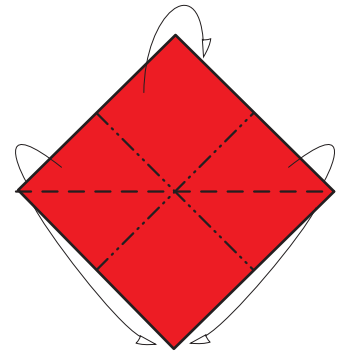

28. Tamaño del papel 5x5 cm.

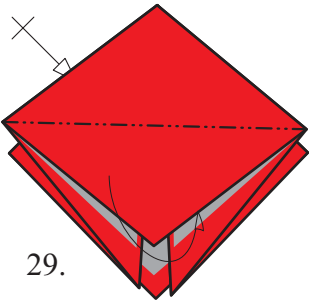

29.

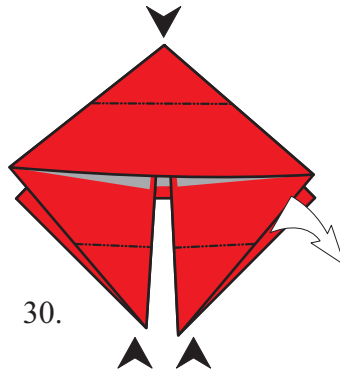

30.

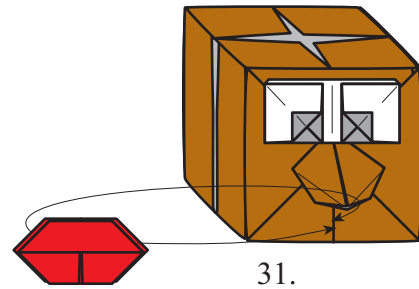

31.

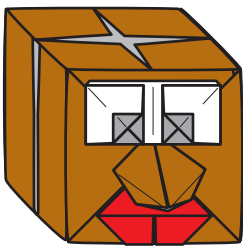

32.

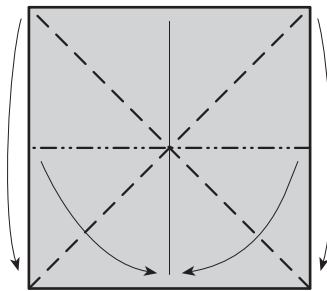

33. 

 5 cm  
 5 cm

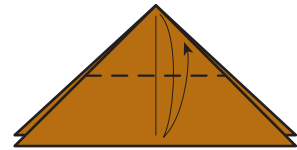

34.

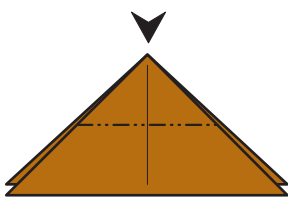

35.

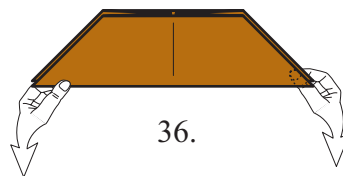

36.

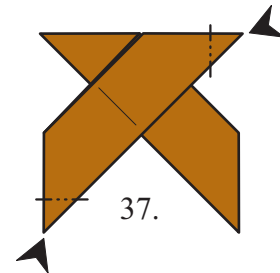

37.

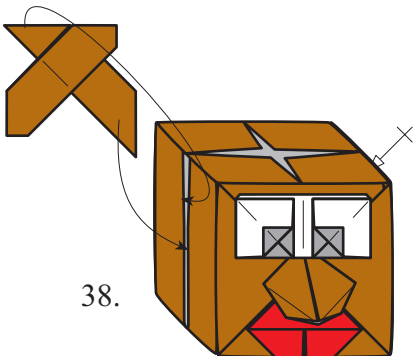

38.

39.

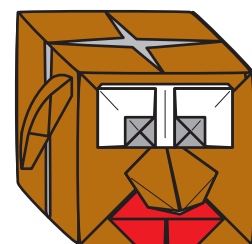
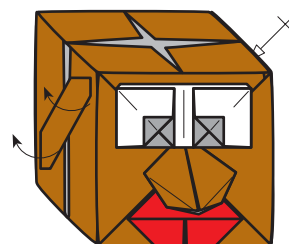

40.

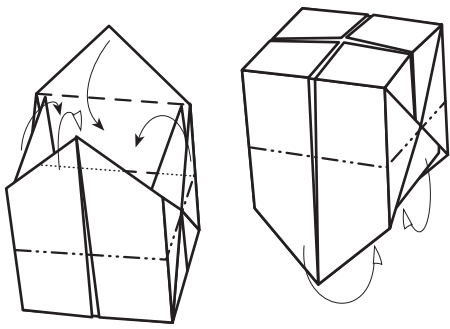

41. Dos módulos básicos de 20 cm.

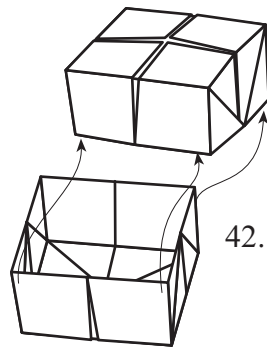

42.

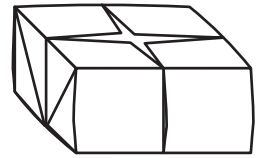

43.

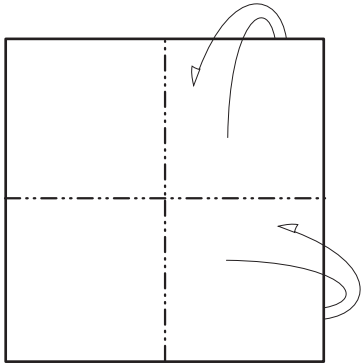

44. Tamaño del papel 20x20 cm.

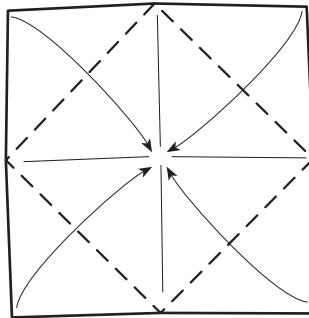

45.

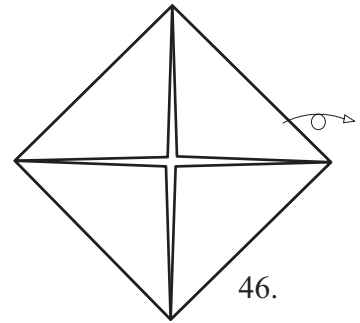

46.

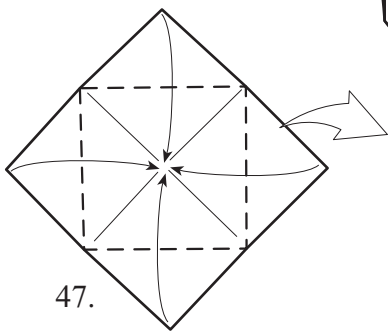

47.

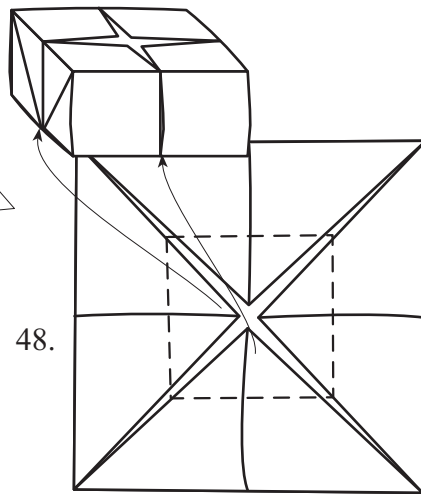

48.

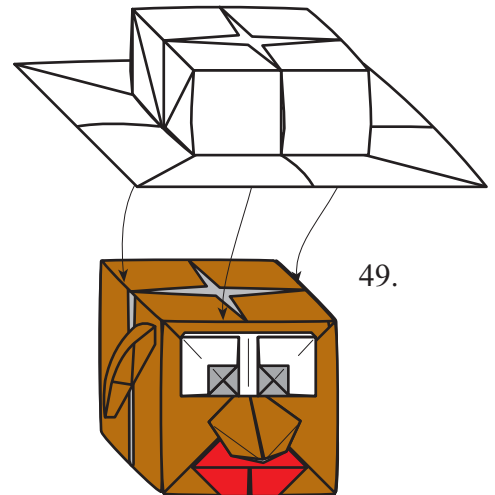

49.

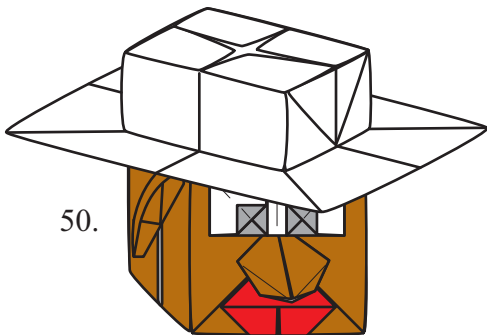

50.

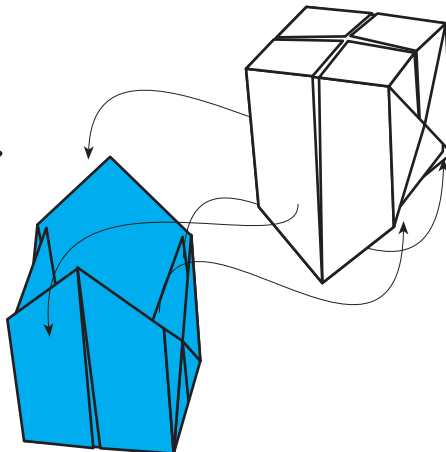

51. Dos módulos básicos de 20 cm.

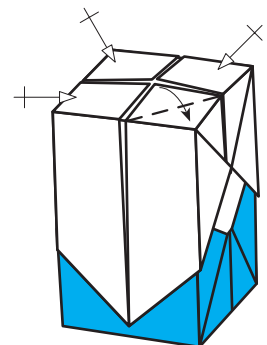

52.

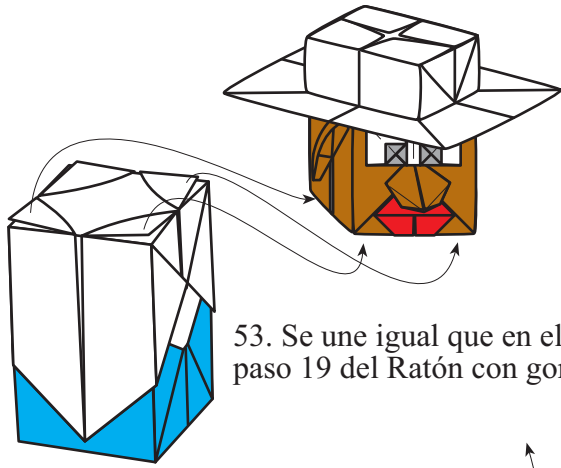

53. Se une igual que en el paso 19 del Ratón con gorra.

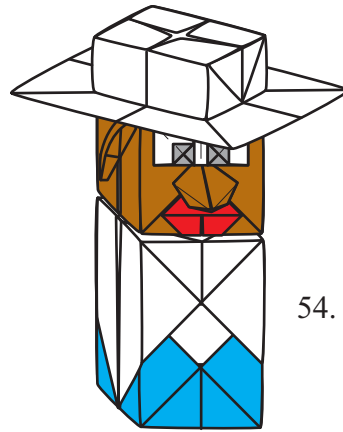

54.

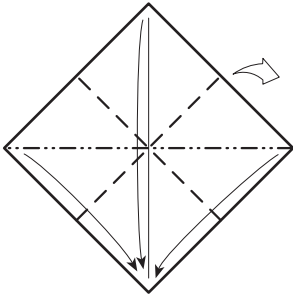

55.   10 cm

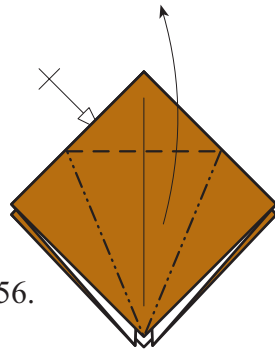

56.

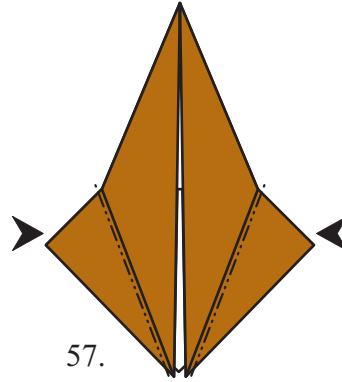

57.

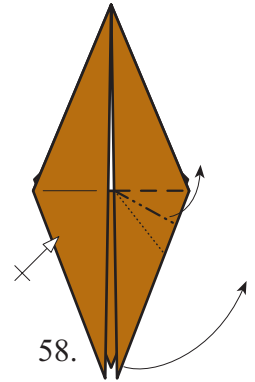

58.

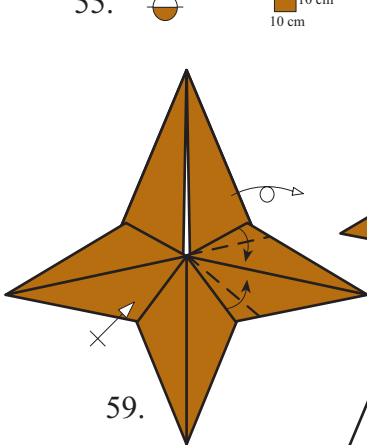

59.

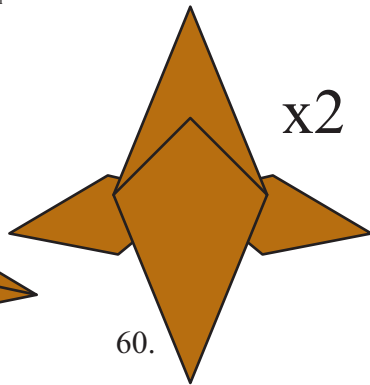

60.

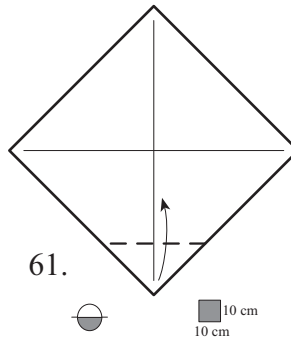

61.

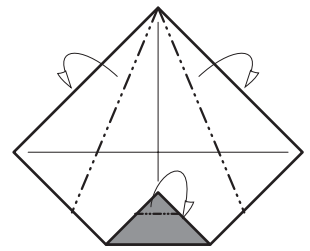

62.

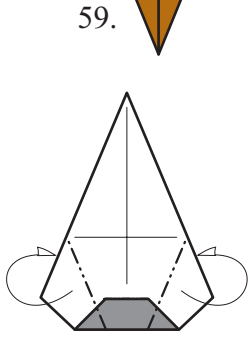

63.

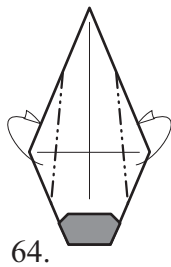

64.



65.

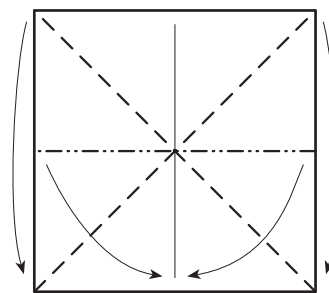

66.

 5 cm

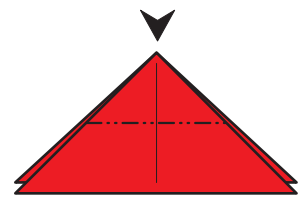

67.



68.

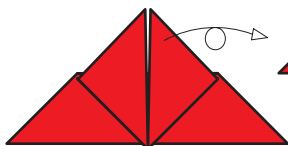

69.

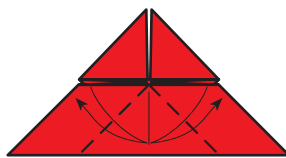

70.

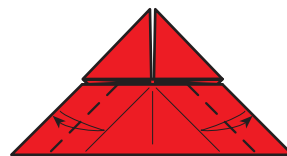

71.



72.

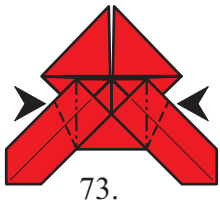

73.

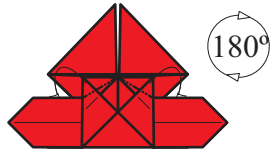

74.



75.

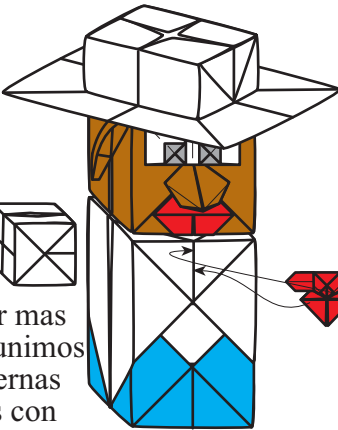
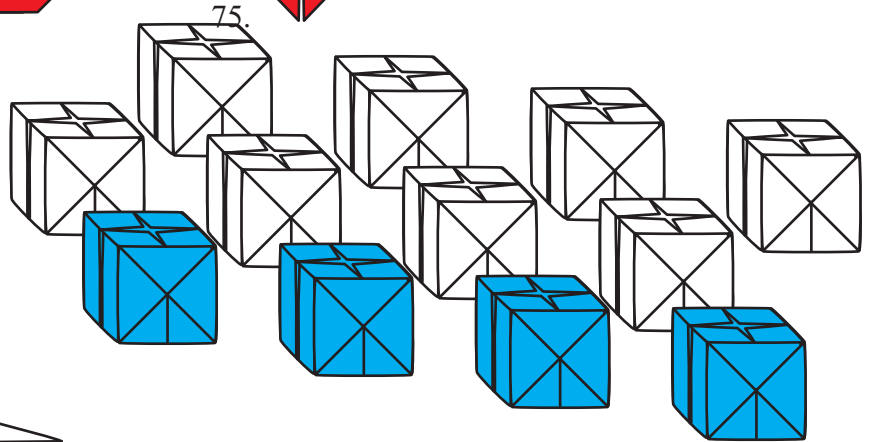

55. Con papeles de 10 cm. hay que plegar 12 piezas como la del paso 14. De las 12 piezas hay que plegar 8 en blanco y 4 en azul.

56. Para dar mas movilidad unimos brazos y piernas cosiendolas con un cordel.

