

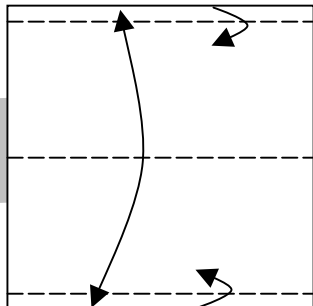

ELEPHANT 4

DESIGN AND DIAGRAM BY
MICKAEL COUROUBLE

A 50 cm square gives a 25x10 cm elephant.



1. Start with white side up. Fold and unfold the middle line. Fold at about 1/18 in the upper and lower sides. This length will be equal to the width of the legs.

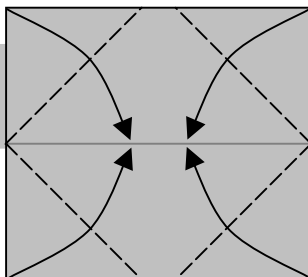

2. Bring the corner along the middle line.

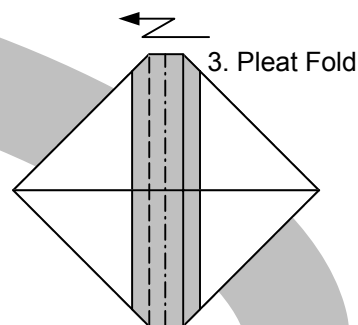

3. Pleat Fold

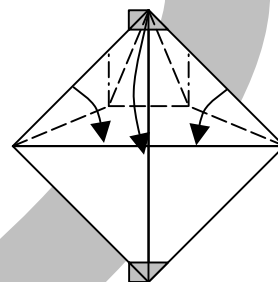

4. Swivel Fold

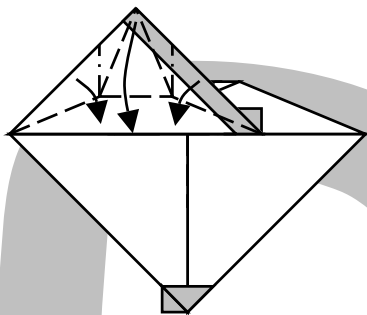

7. Swivel Fold

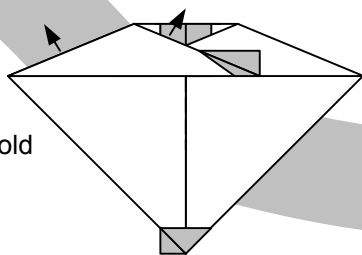

6. Extract the layer. Be careful, it should be the layer which is blocked by the leg.

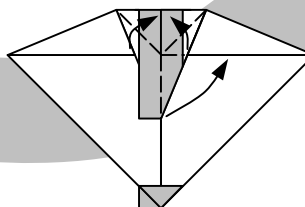

5. Swivel Fold

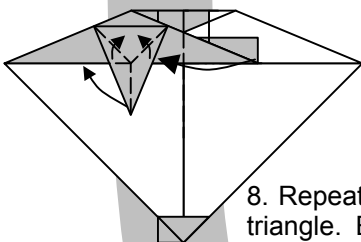

8. Repeat step 5 on the small triangle. Bring the leg to the left.

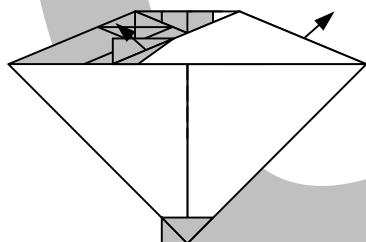

9. Extract the layer

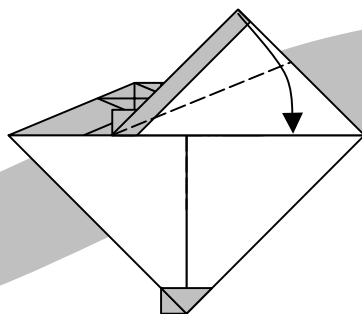

10. bring the left side to the middle line.

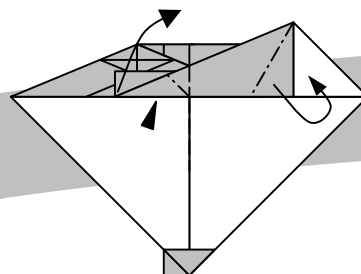

11. Squash Fold on the leg. Mountain fold the upper layer.

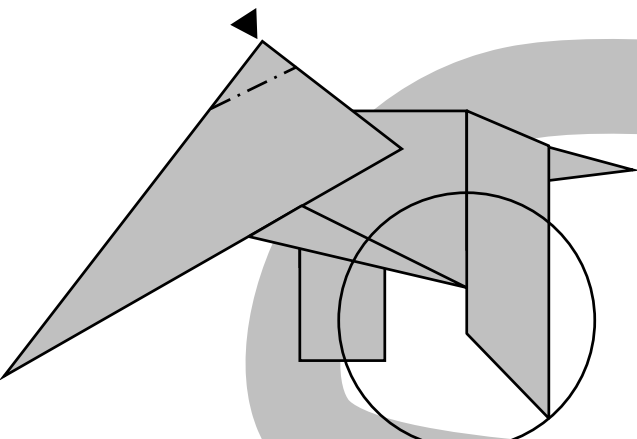

19. Shape the top of the head. X-ray view in the circle.

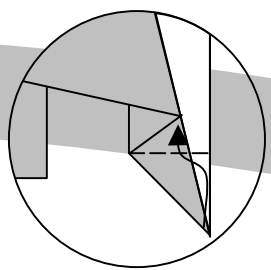

20.

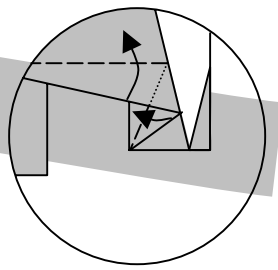

21. Swivel Fold

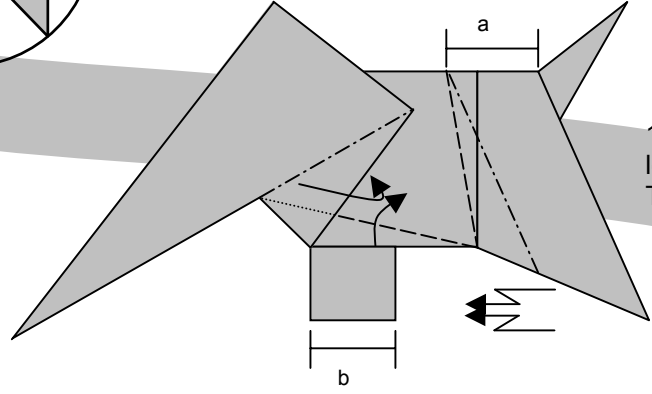

18. Make a swivel fold on the left and a crimp on the right. The length a is equal to b.

16. Fold as shown. The triangle on the left becomes the head and the rectangular becomes the neck

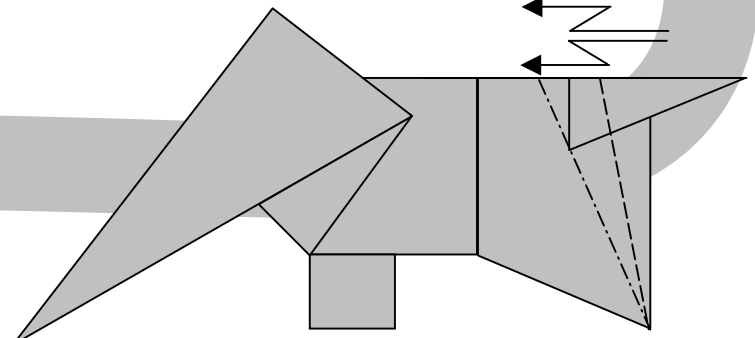
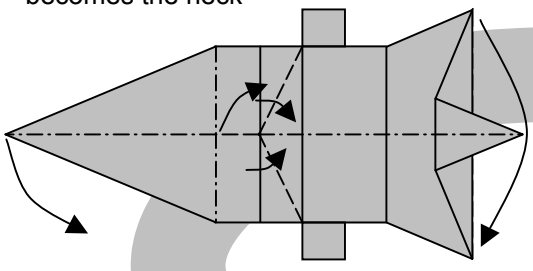

17. Crimp the rear part of the elephant.

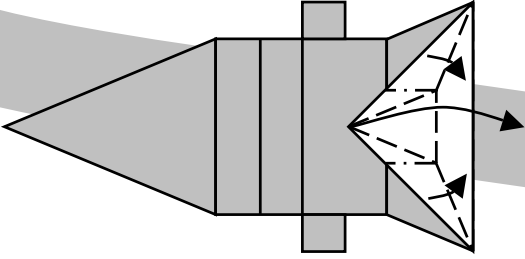

15. Repeat step 4 on the white triangle.

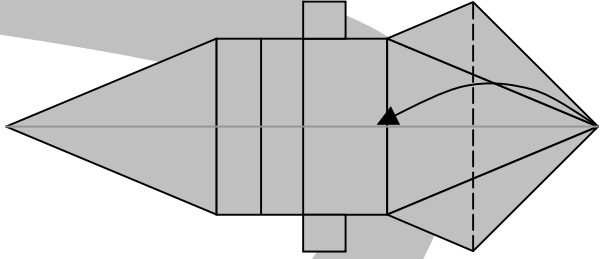

14. Fold the right triangle as shown.

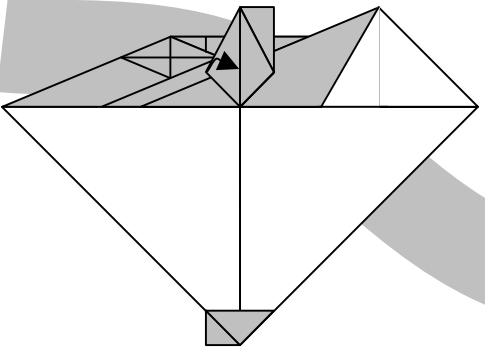

12. tuck the triangle into the leg pocket.

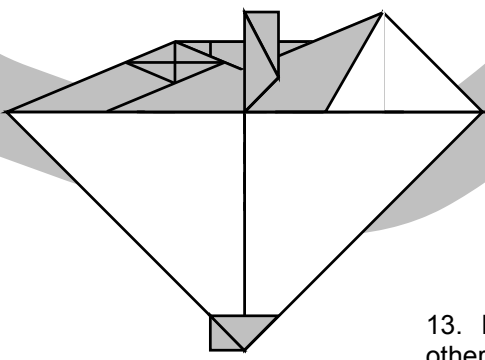

13. Repeat steps 4-12 on the other side and turn over the model.

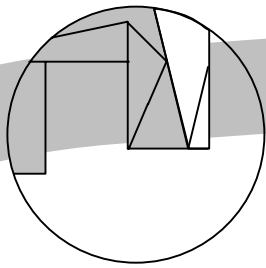

22.The result. Repeat steps 20-21 on the other leg.

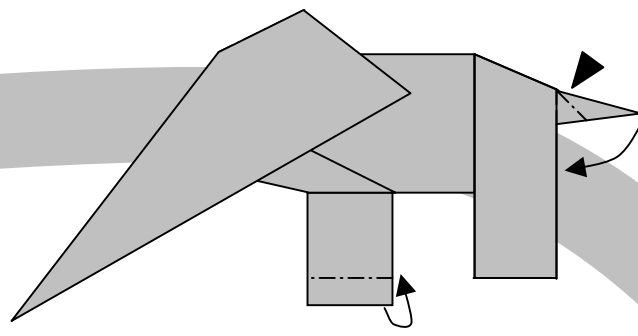

23.Make a squash fold to shape the tail and a mountain fold to have 4 legs with the same length.

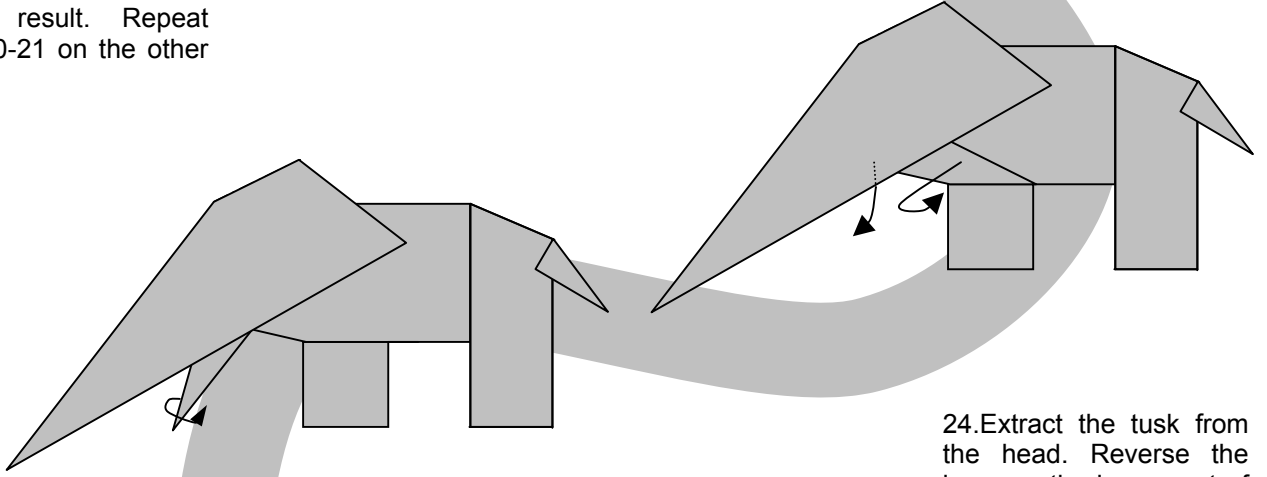

25. Change the colour of the tusk.

24.Extract the tusk from the head. Reverse the layer on the lower part of the neck

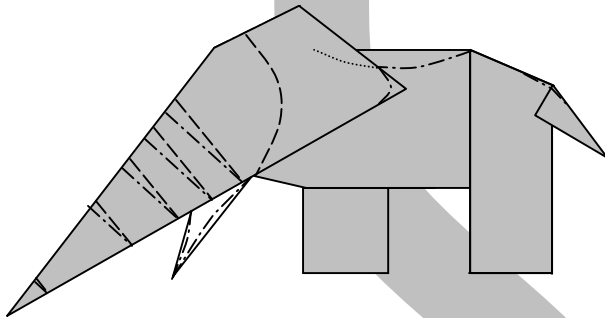

26.. Shape the trunk with many crimps and shape the body and the leg.

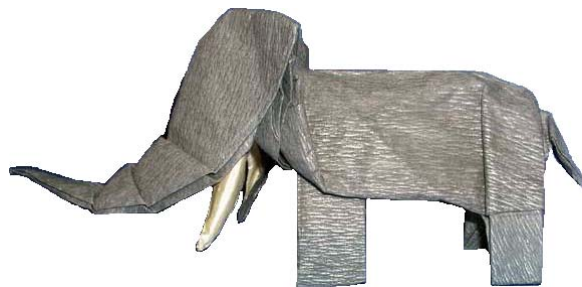

27. The final result.

This Diagram can be downloaded on [Kael Kael Origami](#)
Or on [Design in Origami](#)