

Utilizando las medidas recomendadas, se obtiene un modelo final de 14 cms	
Autor:	Halle
Nivel de dificultad:	Medio-Alto
Número de piezas:	8
Forma de las piezas:	Cuadrados

Discover other models by Halle and download new diagrams at <http://design.origami.free.fr>

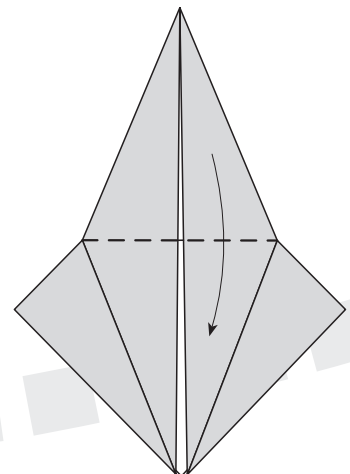

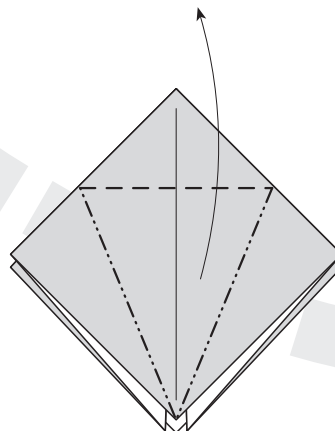

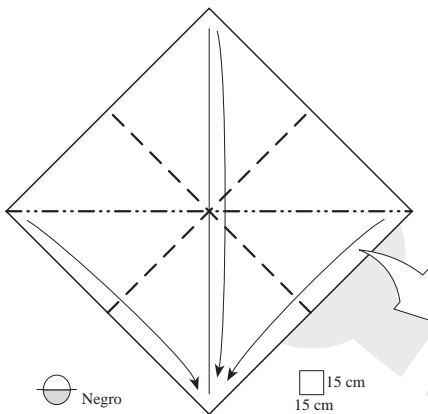
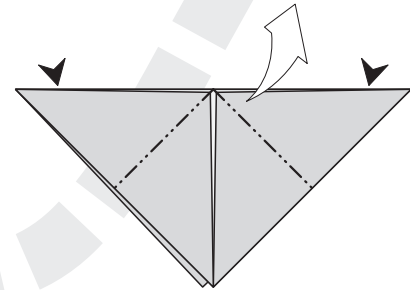
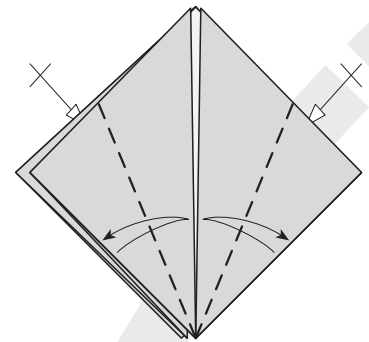
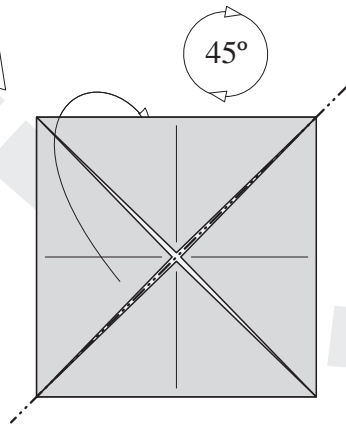
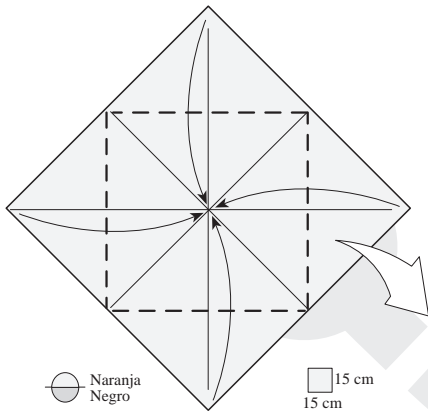
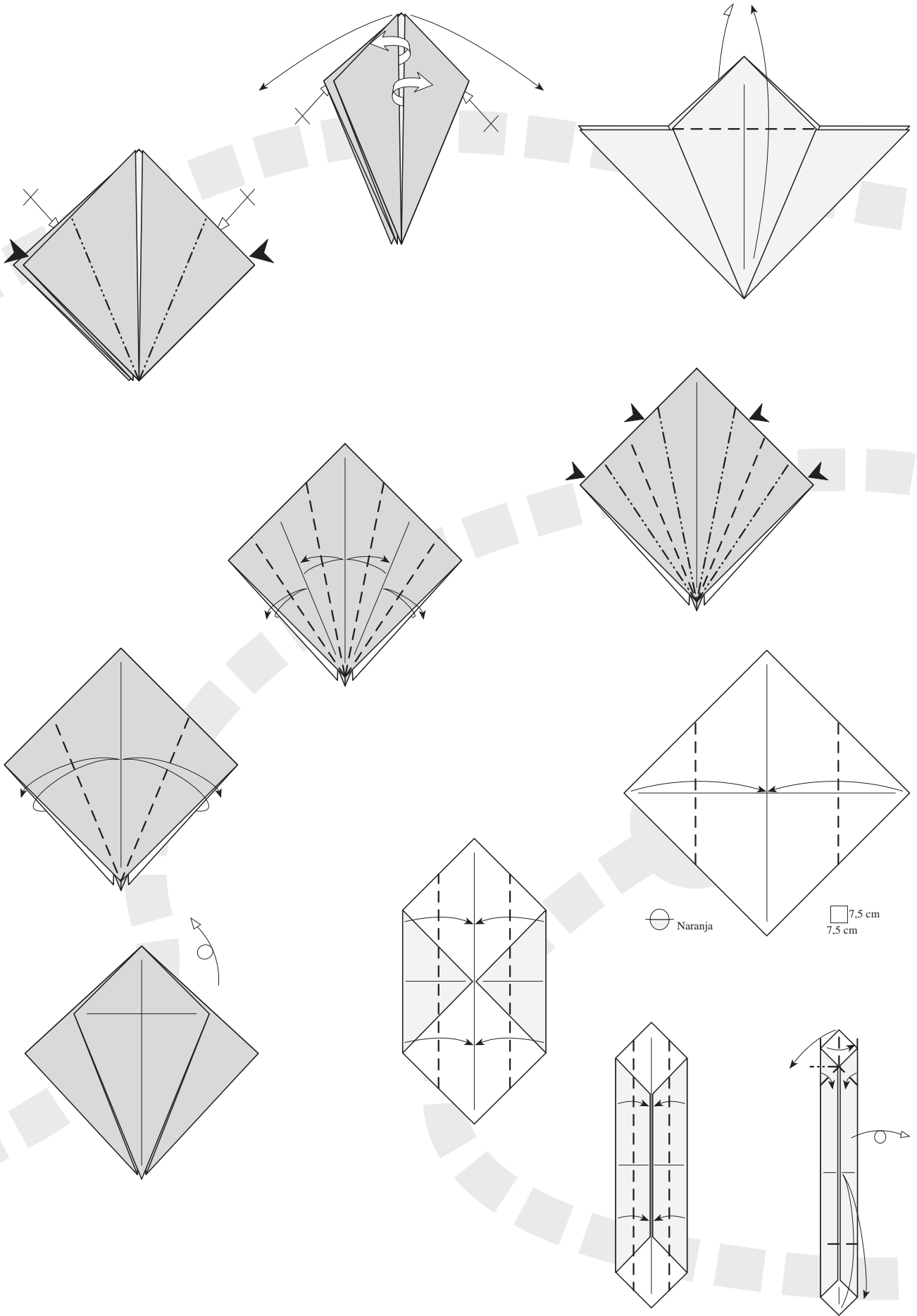
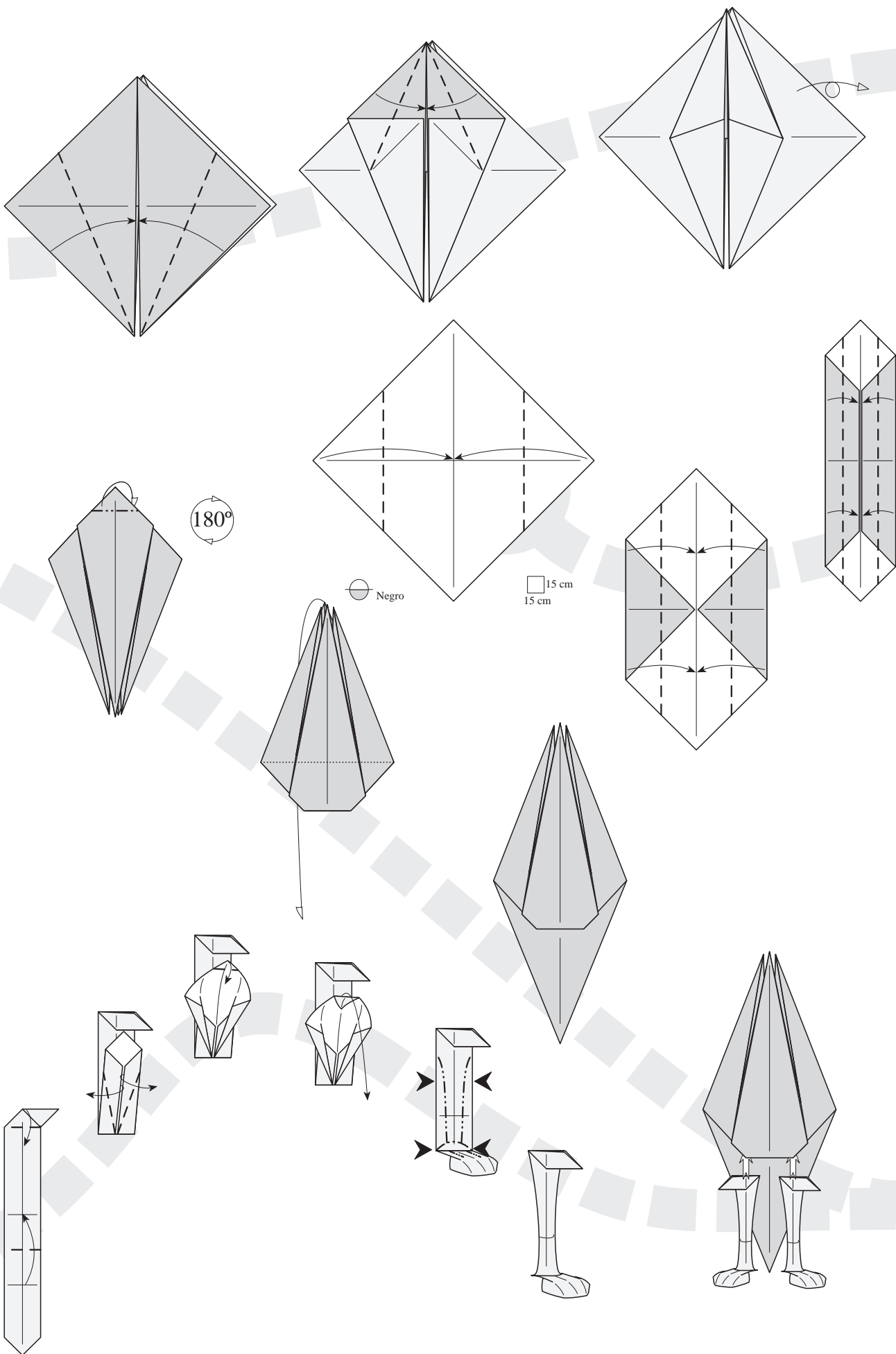

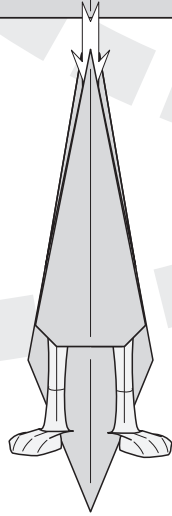
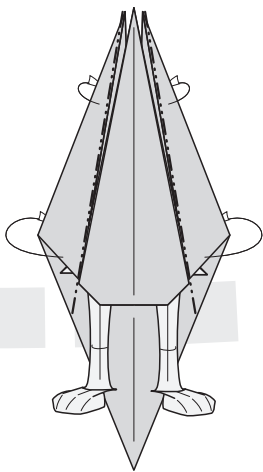
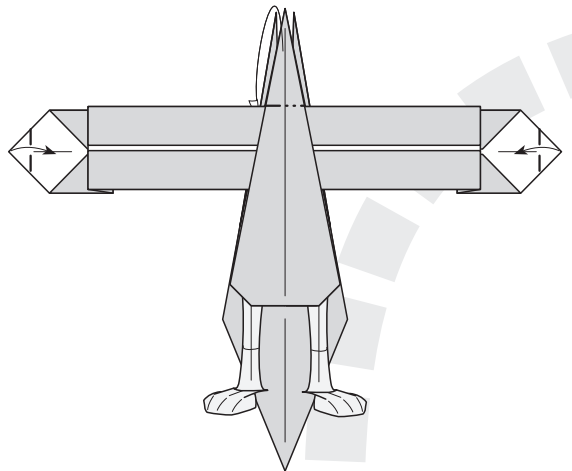
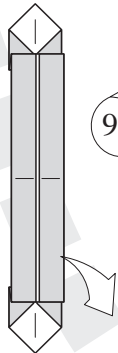
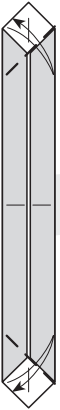
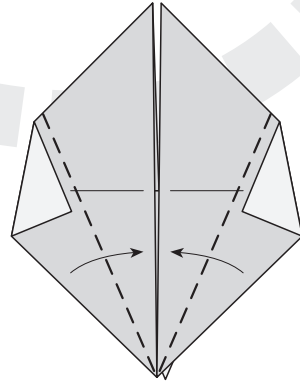
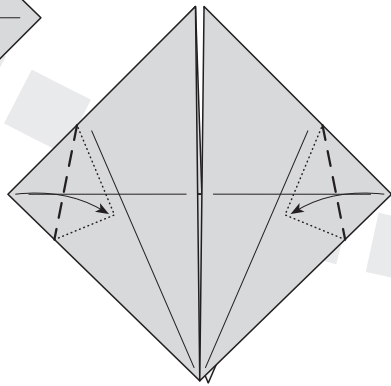
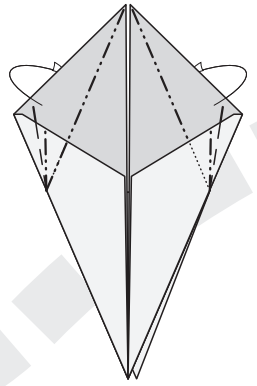
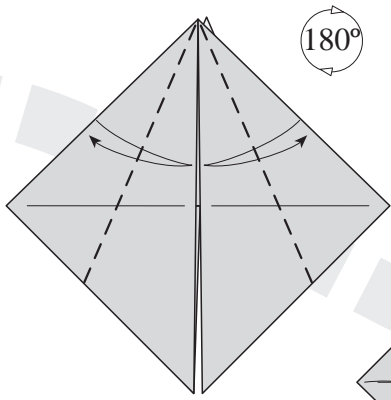

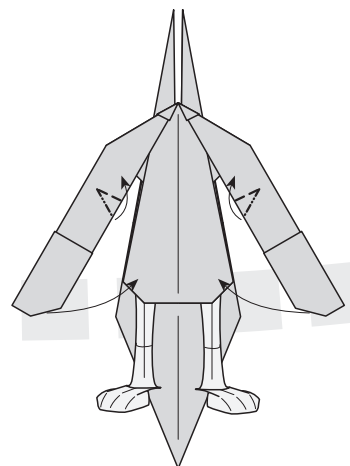
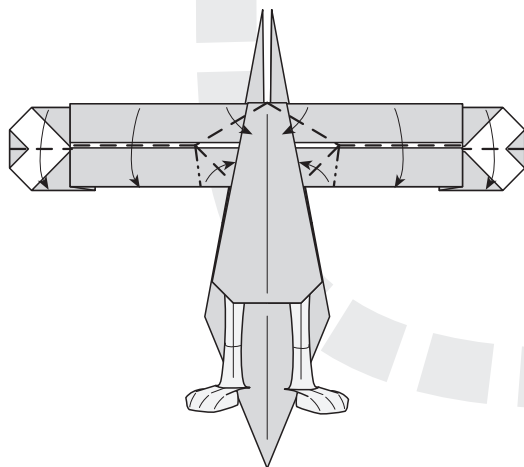
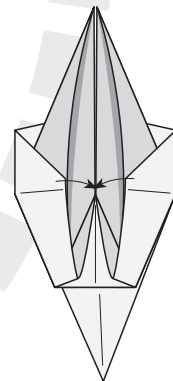
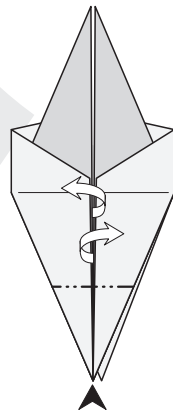
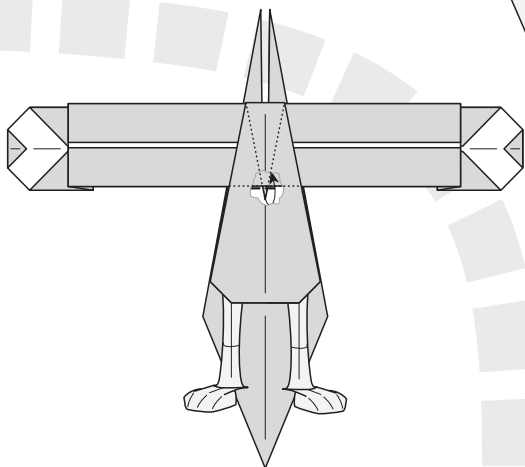
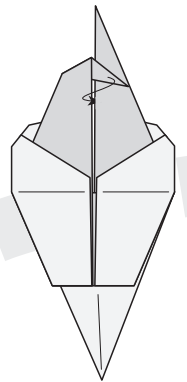
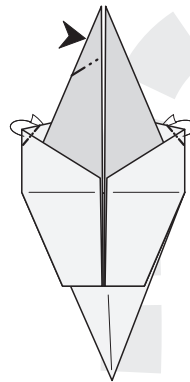
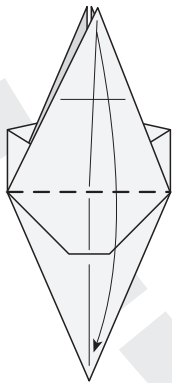
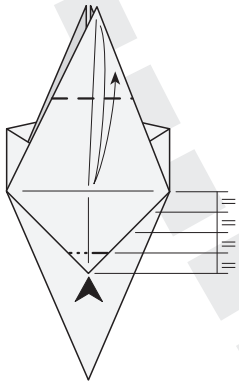
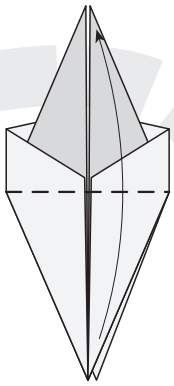

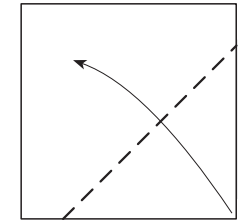
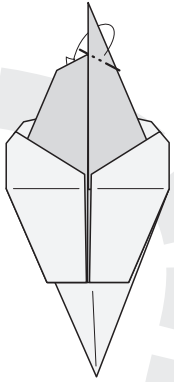

○ Blanco
○ Azul

□ 2 cm
□ 2 cm

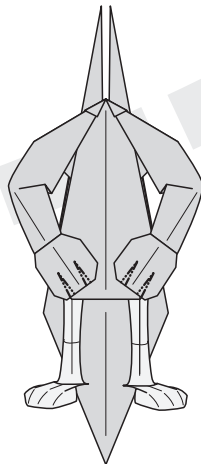
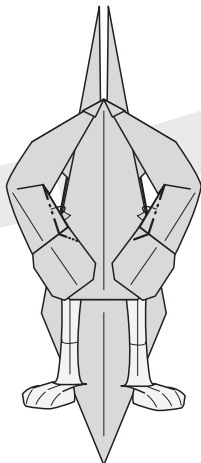
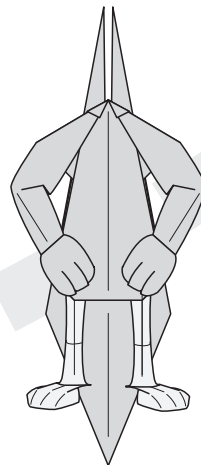
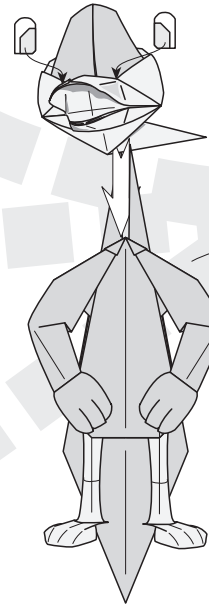
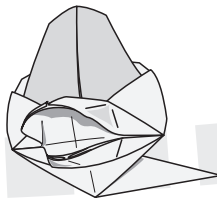
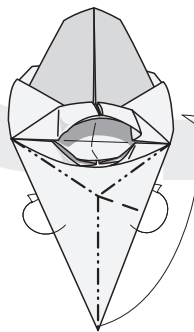
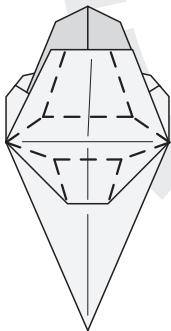
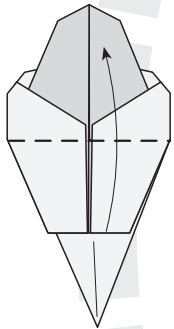
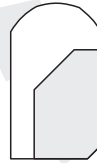
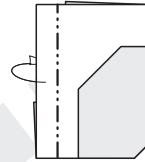
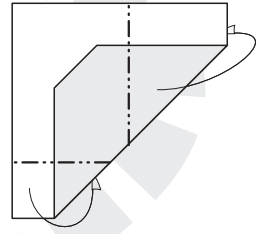
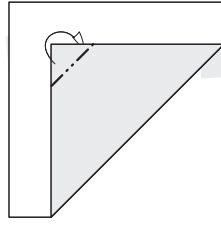

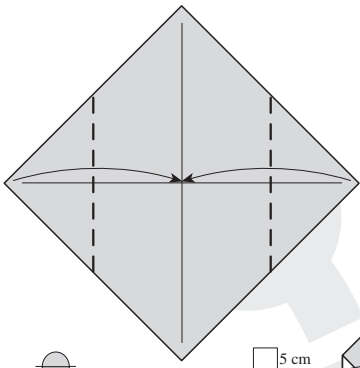

5 cm
5 cm

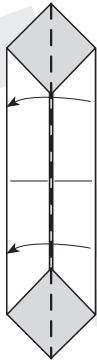
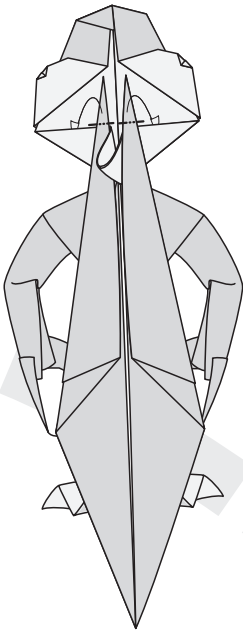
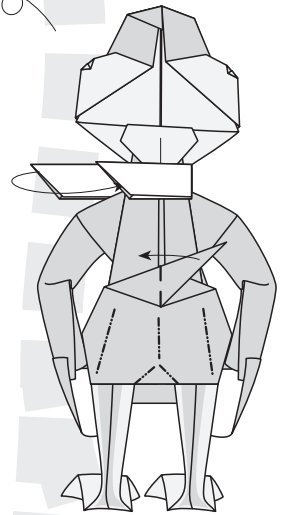
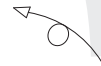
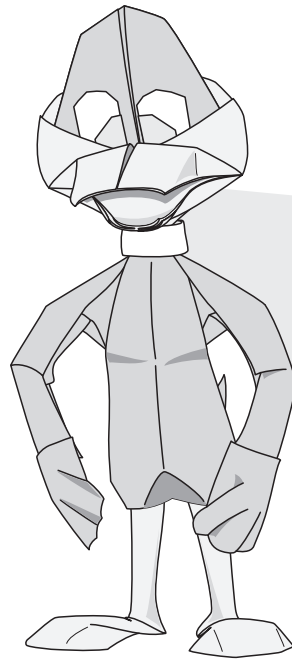
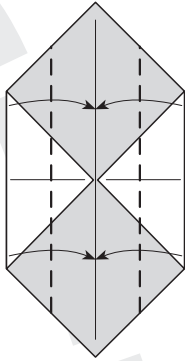

90°

