

Autor:	Halle
Nivel de dificultad:	Medio-Alto
Número de piezas:	9
Forma de las piezas:	Cuadrados

Discover others models by Halle and download new diagrams at <http://design.origami.free.fr>

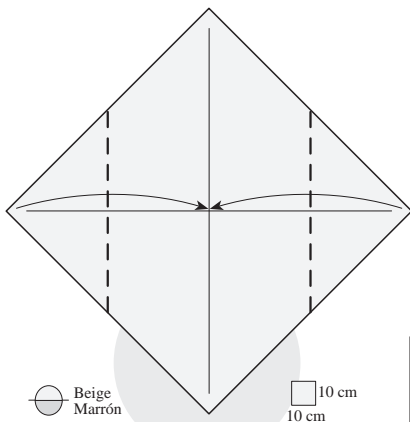

Beige
Marrón

10 cm
10 cm

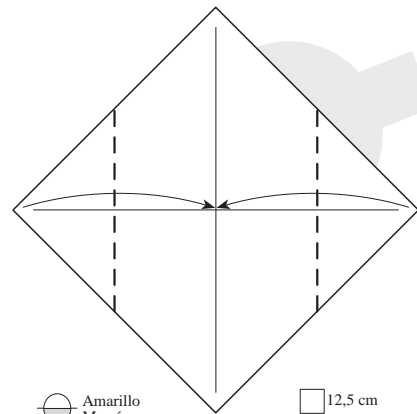
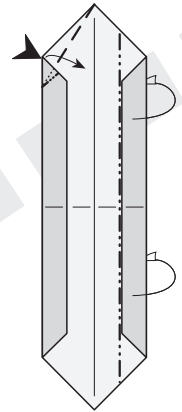
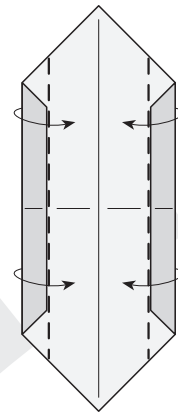
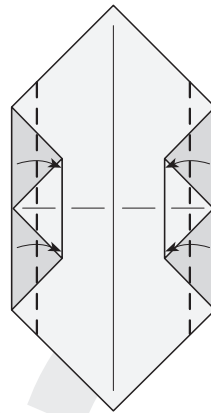
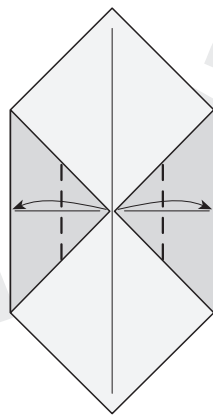

Amarillo
Marrón

12,5 cm
12,5 cm

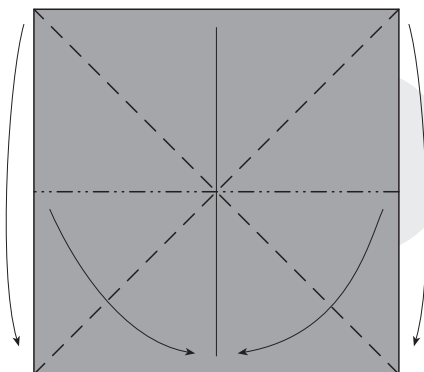

Negro
Beige

15 cm
15 cm

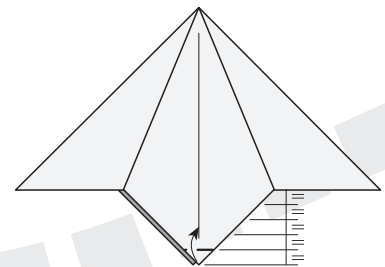
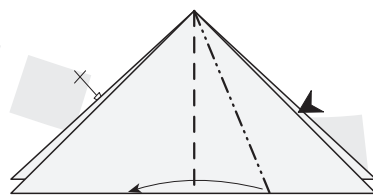

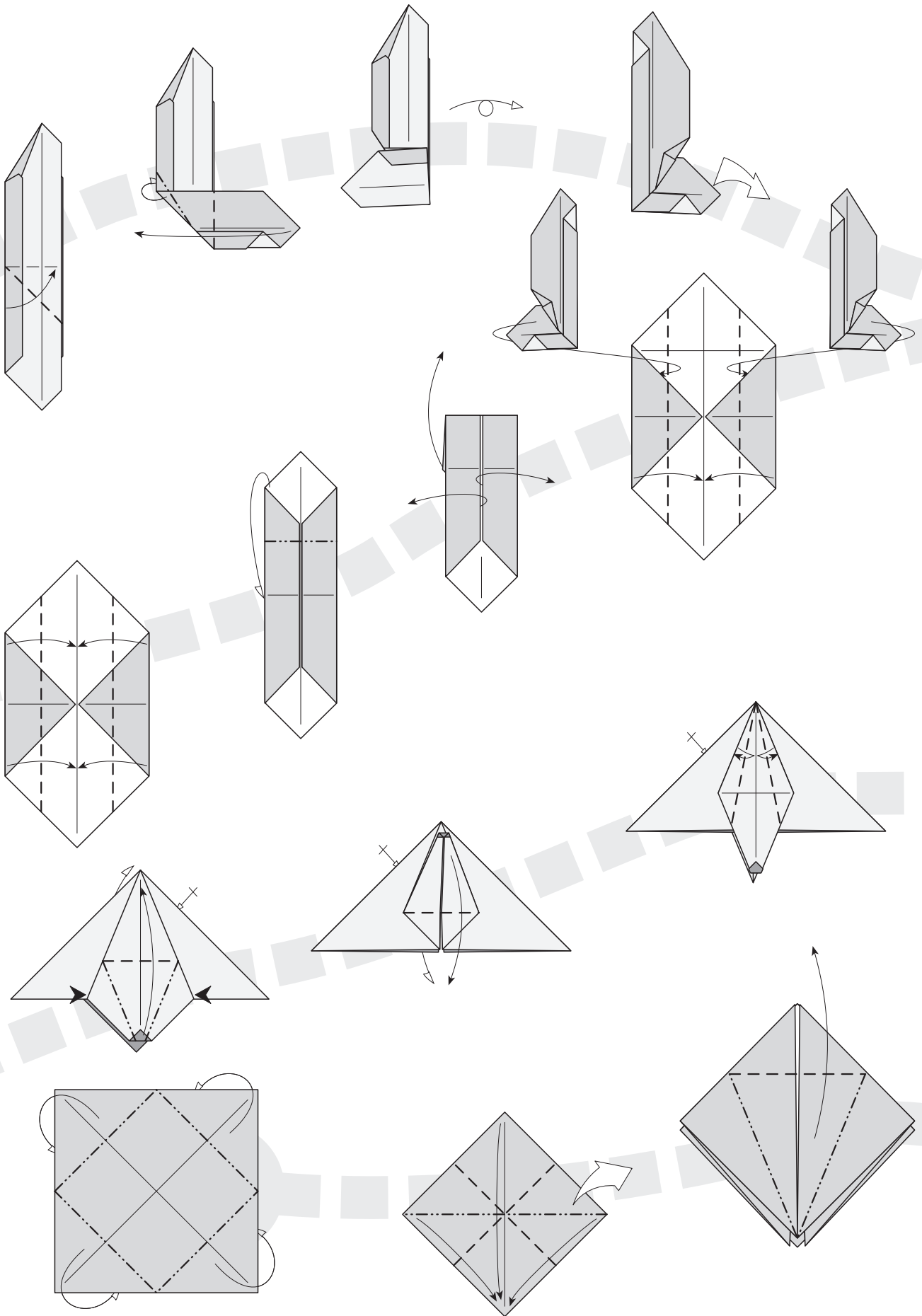

○ Marrón
○ Beige

■ 25 cm
■ 25 cm

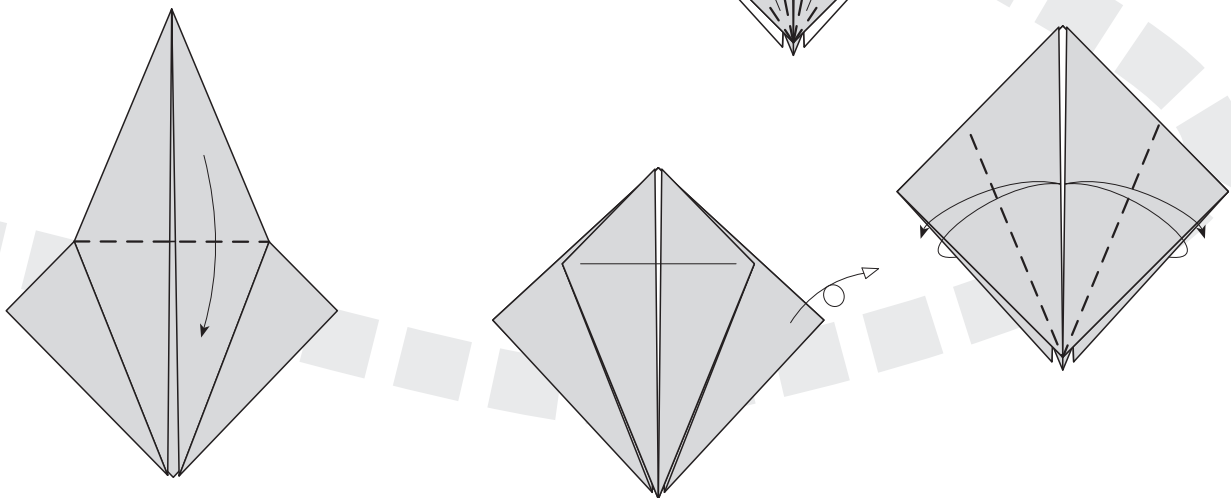
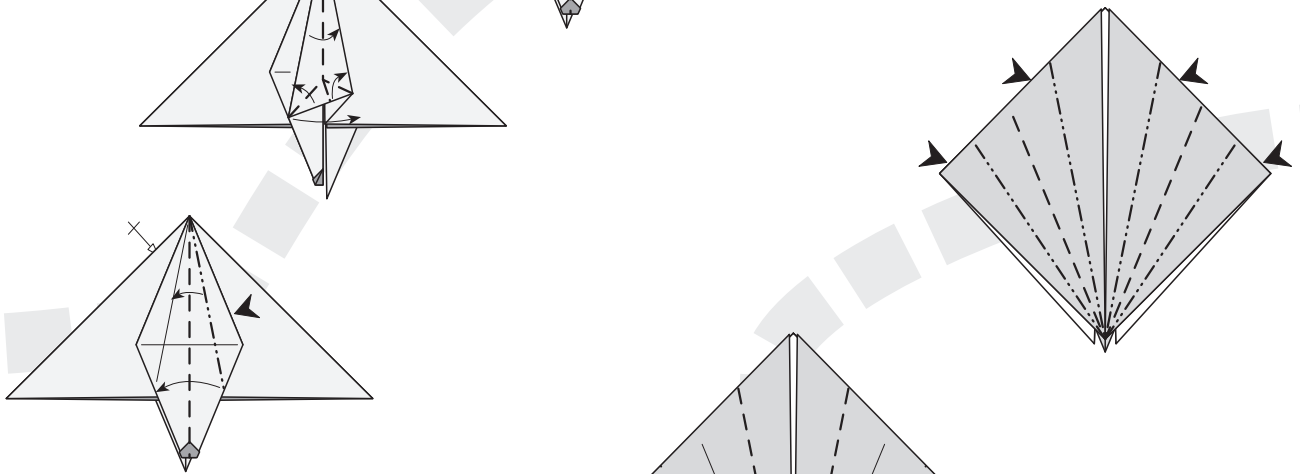
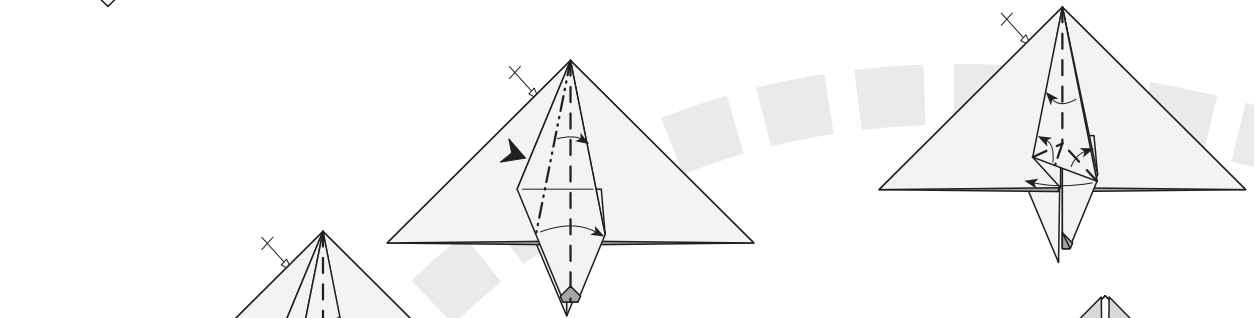
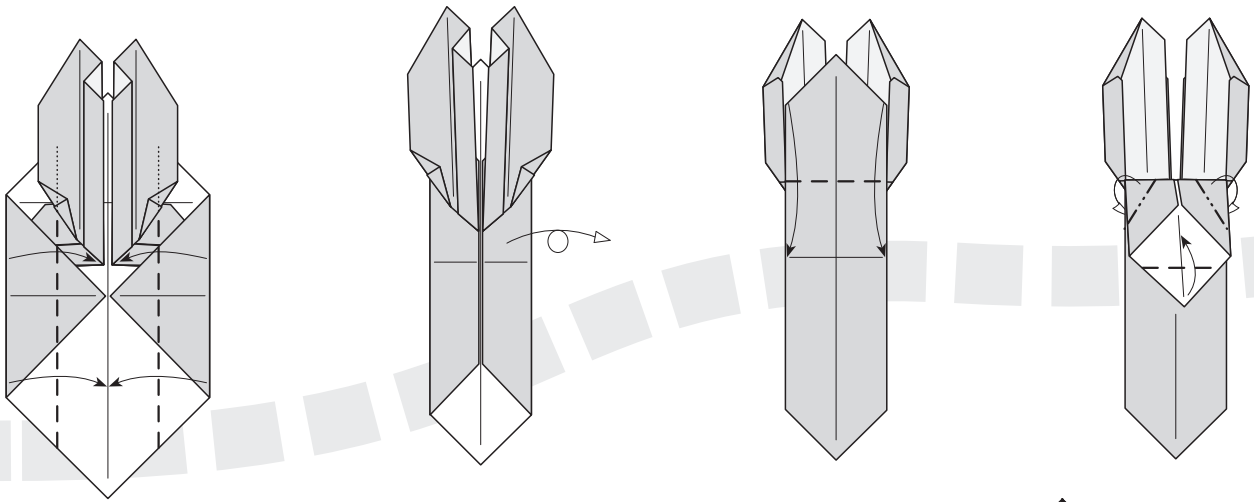

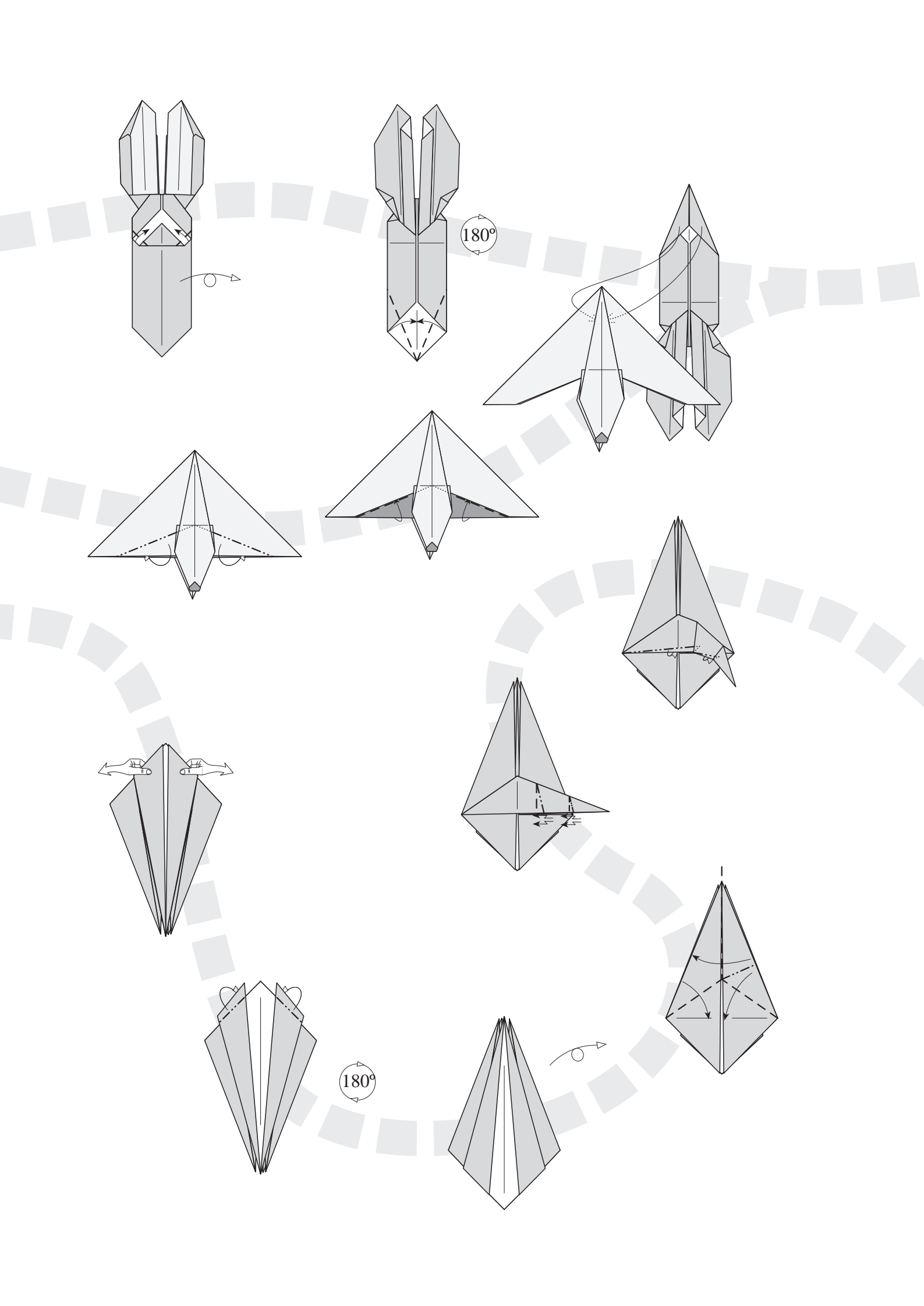

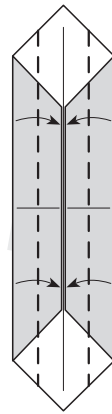
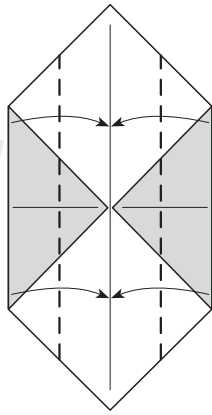
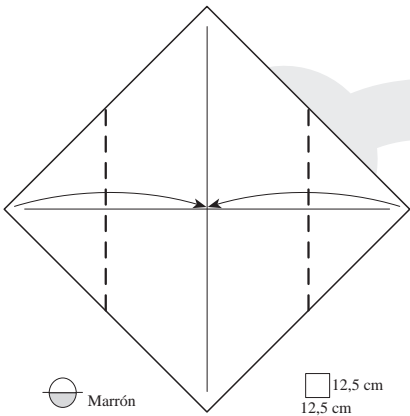
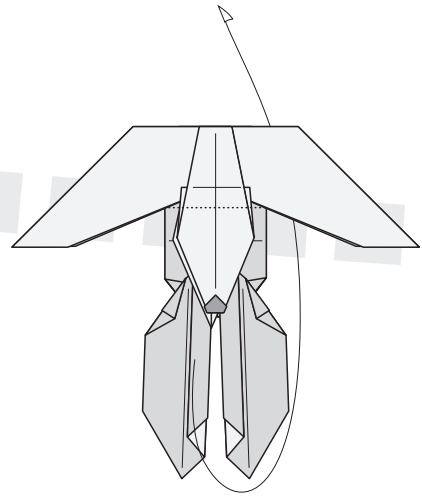
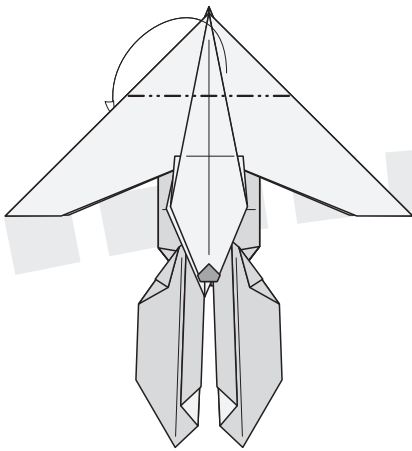

● Marrón

□ 12,5 cm
12,5 cm

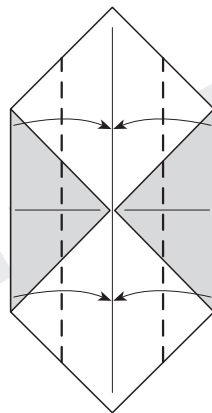
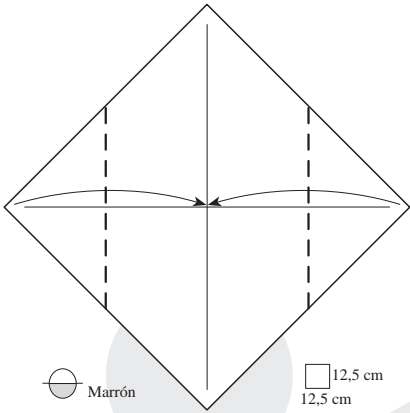
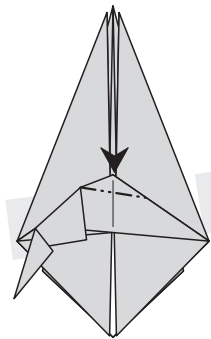
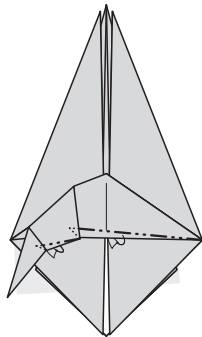
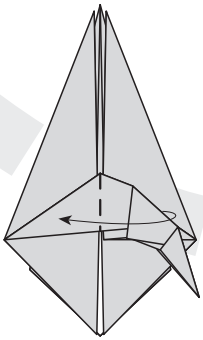

● Marrón

□ 12,5 cm
12,5 cm

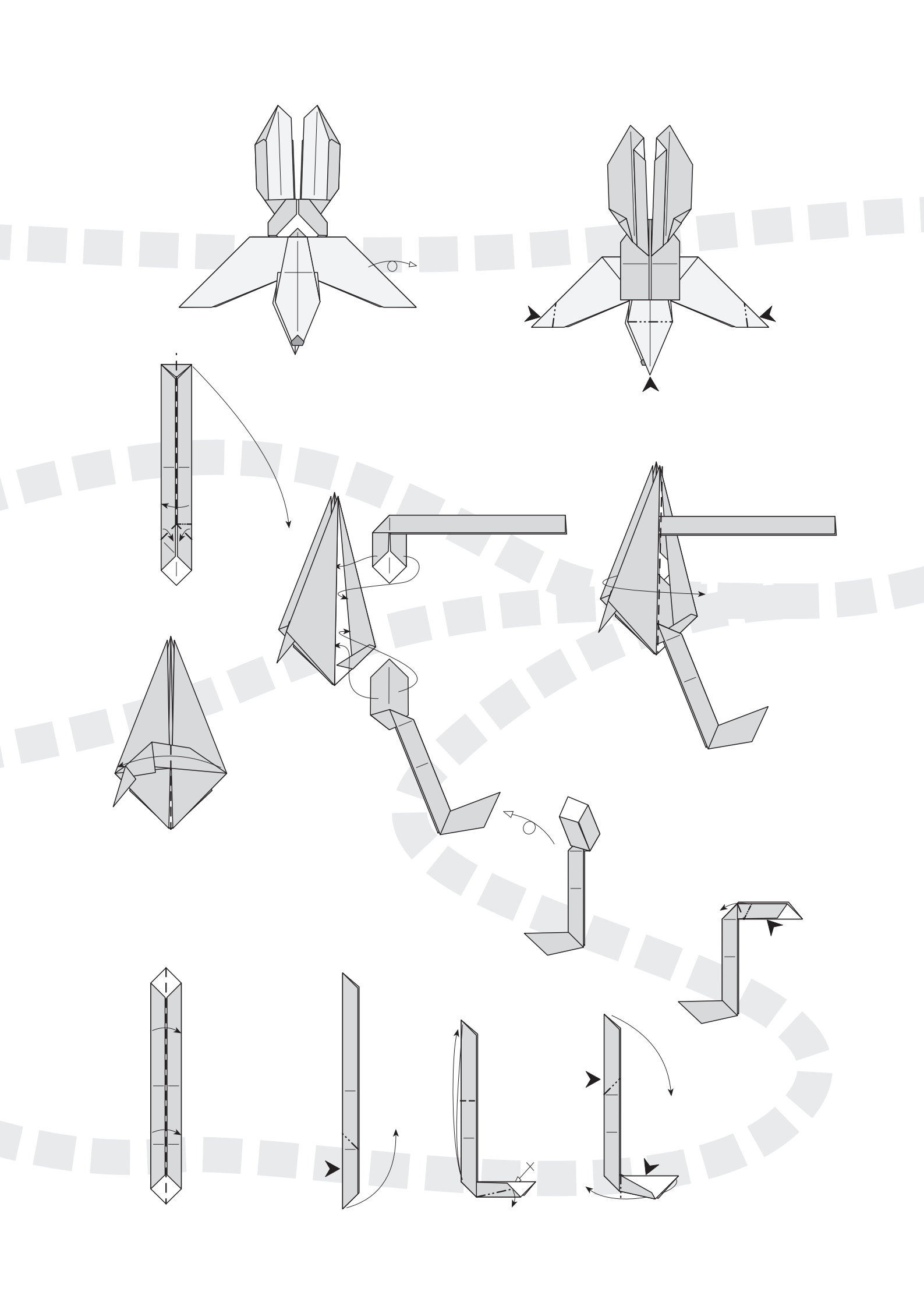

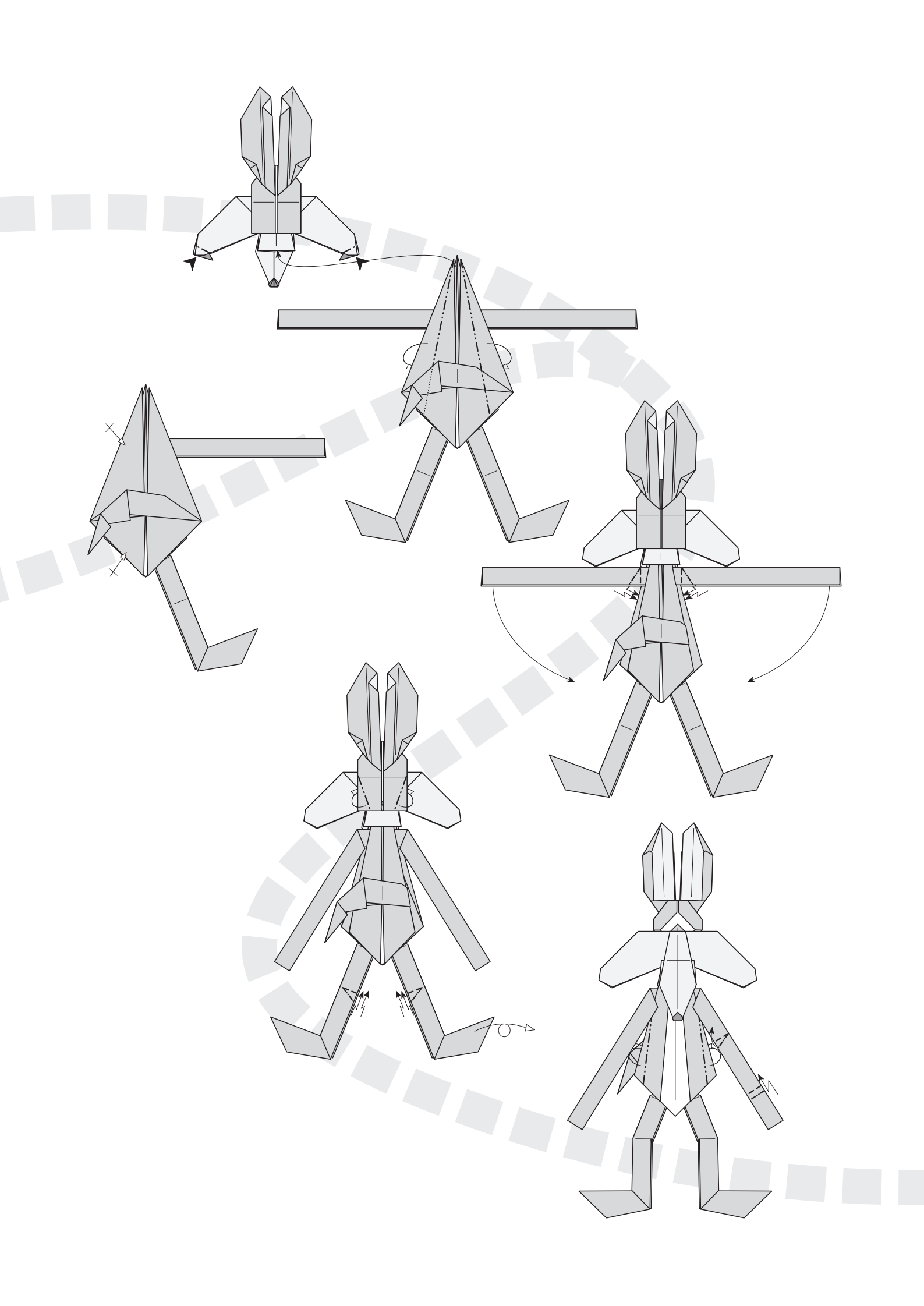

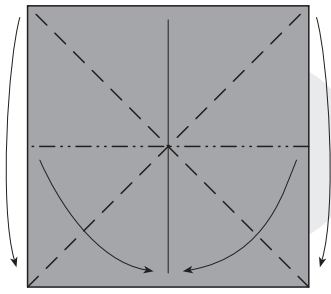

● Negro
○ Blanco

■ 5 cm
■ 5 cm

