

Chily Willy

Autor: Carlos González Santamaría

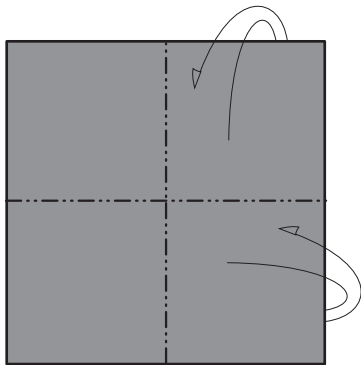

1. Papel 10x10 cm. ☉

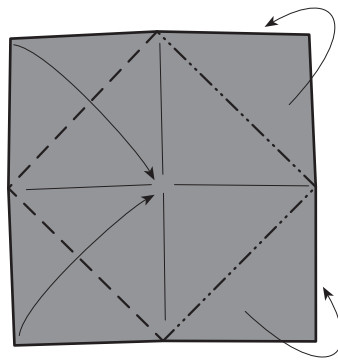

2.

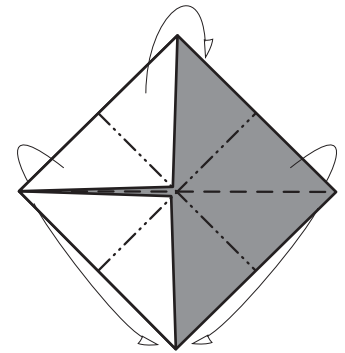

3.

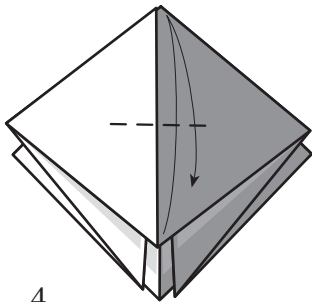

4.

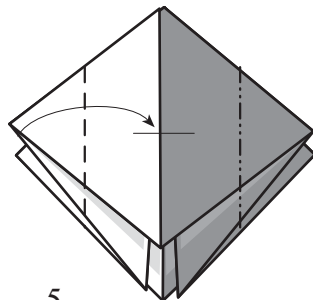

5.

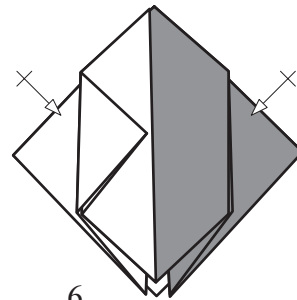

6.

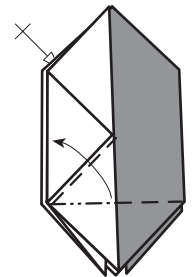

7.

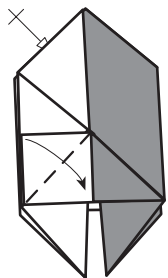

8.

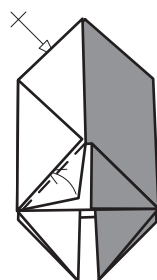

9.

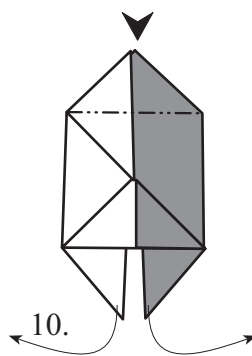

10.

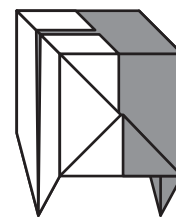

11.

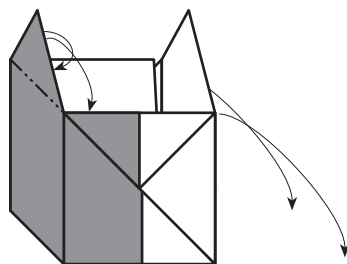

12.

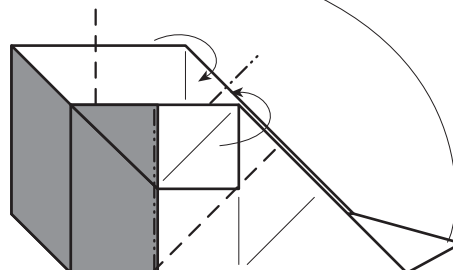

13.

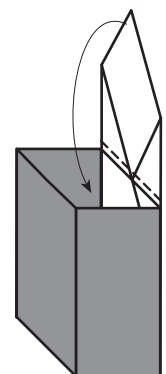

14.

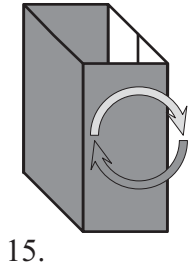

15.

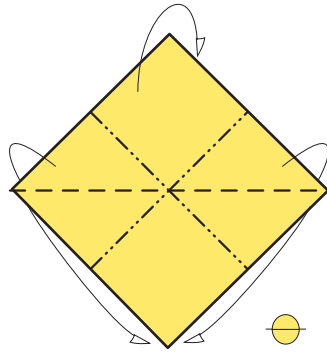

16. Tamaño del papel 2,5x2,5 cm.

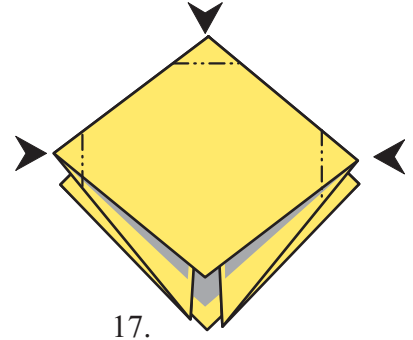

17.

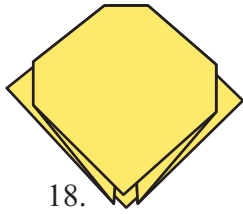

18.

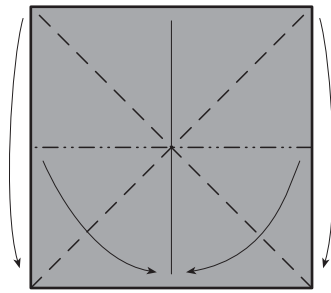

19. Papel 5x5 cm.

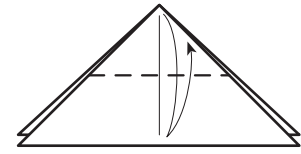

20.

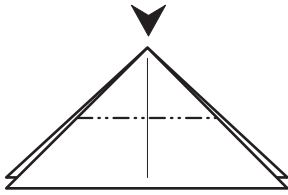

21.

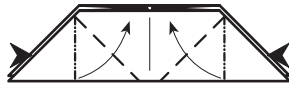

22.



23.

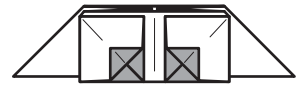

24.

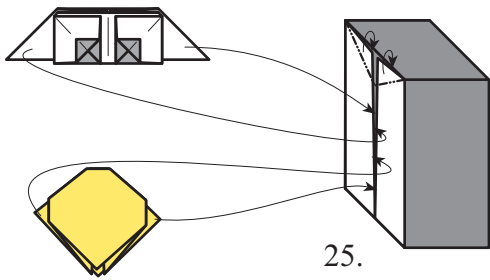

25.

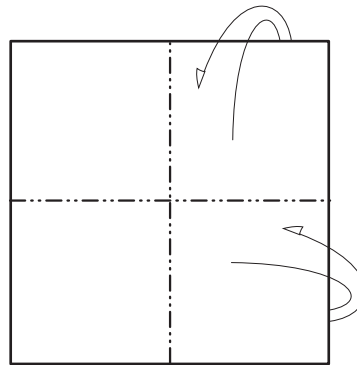

26. Papel 10x10 cm.

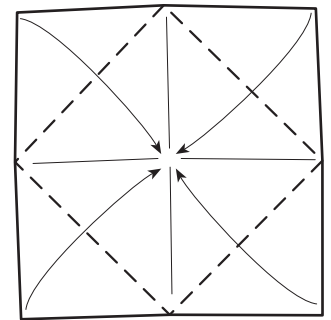

27.

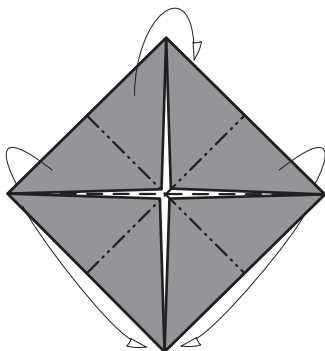

28.

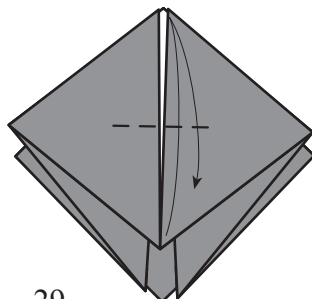

29.

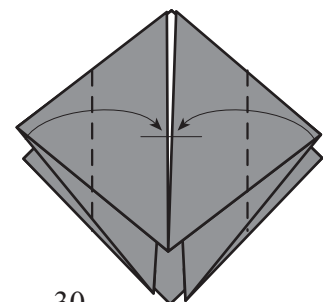

30.

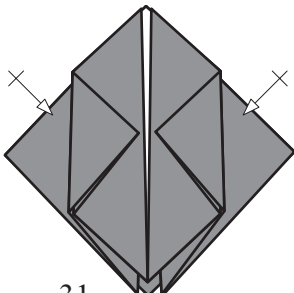

31.

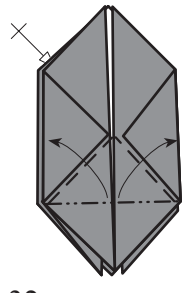

32.

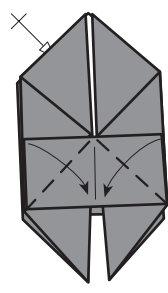

33.

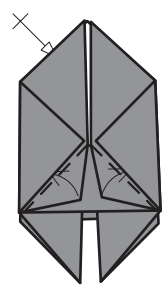

34.

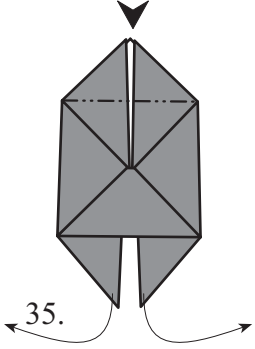

35.

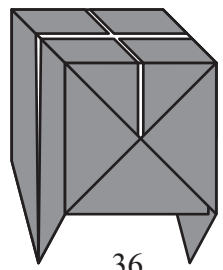

36.

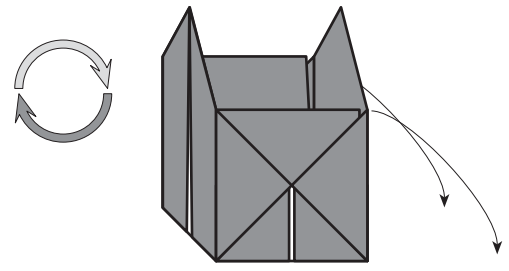

37.

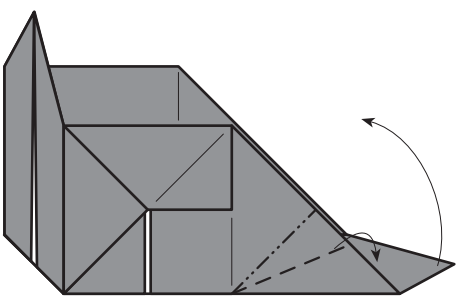

38.

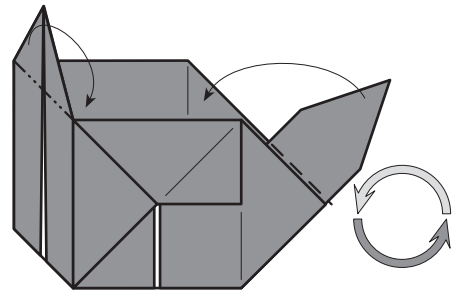

39.

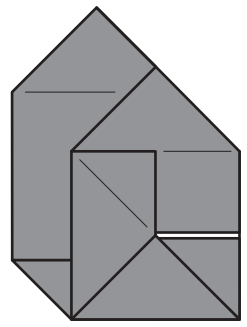

40.

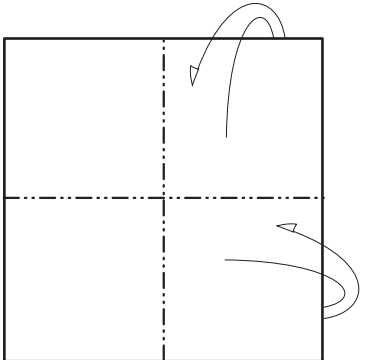

41. Papel 10x10 cm. ⊕

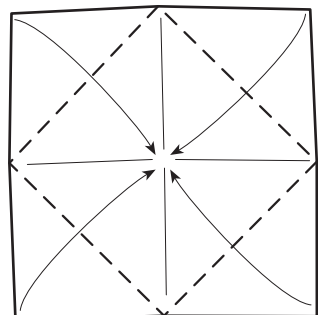

42.

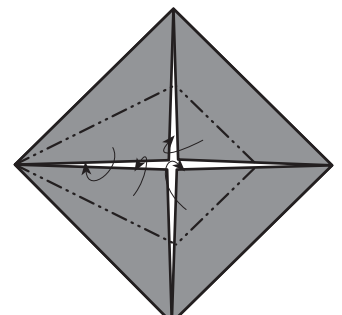

43.

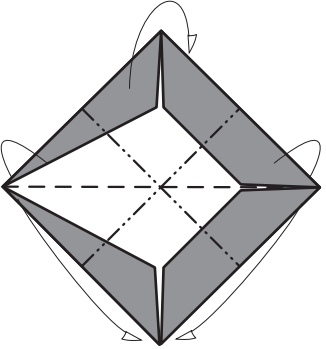

44. Reptir pasos 28 al 39.

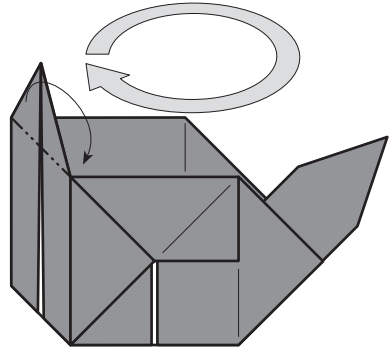

45.

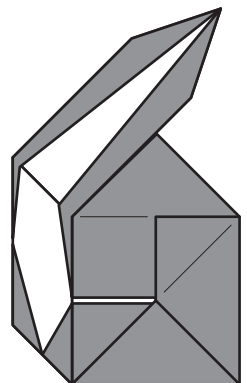

46.

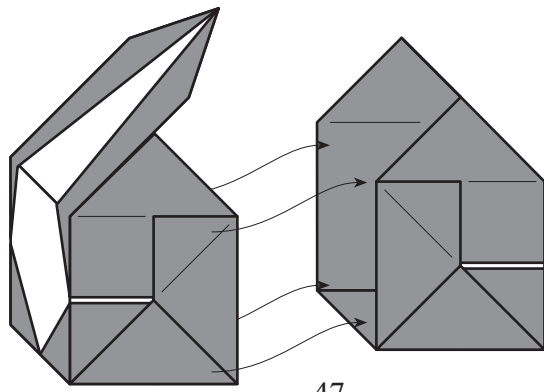

47.

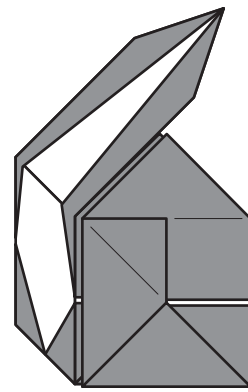

48.

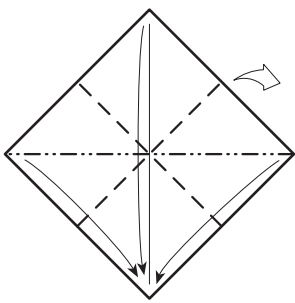

49. Tamaño 10x10. ●

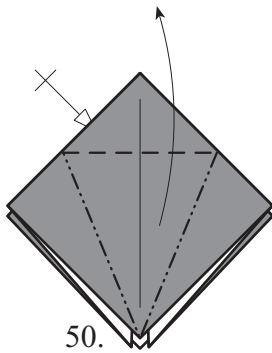

50.

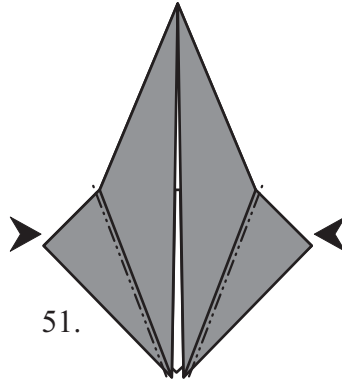

51.

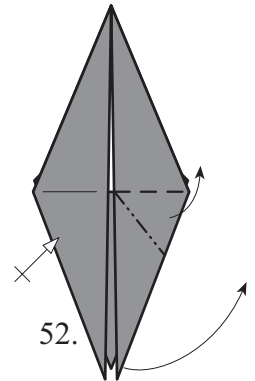

52.

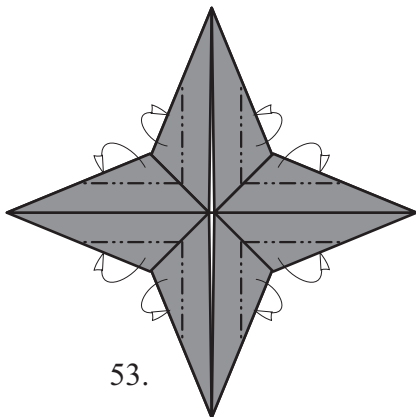

53.

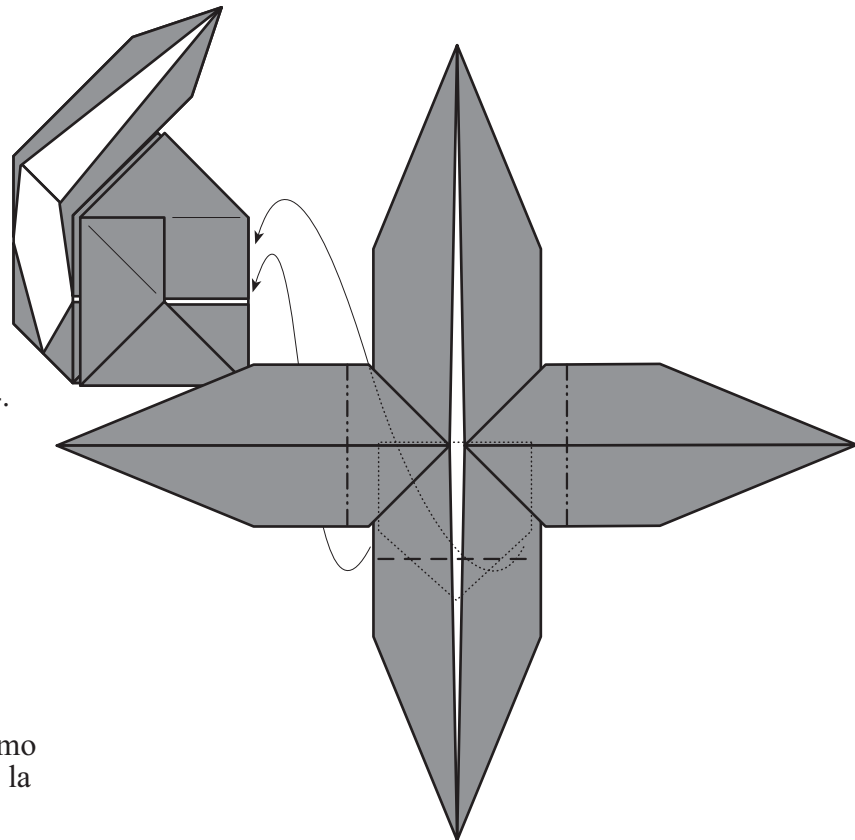

54.

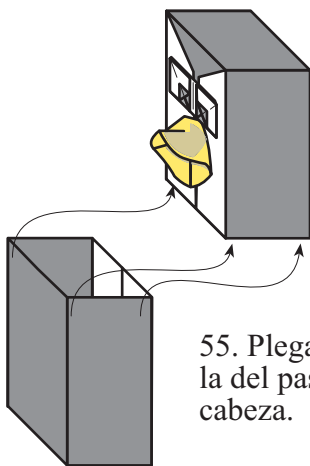

55. Plegar otra pieza como la del paso 15 y unirla a la cabeza.

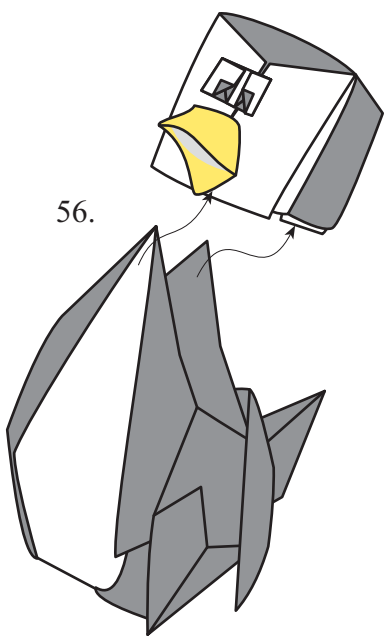

56.

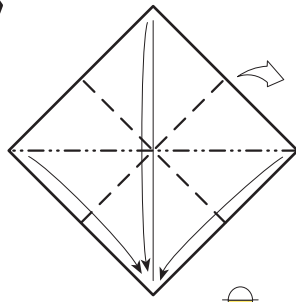

57. Papel 5x5 cm.

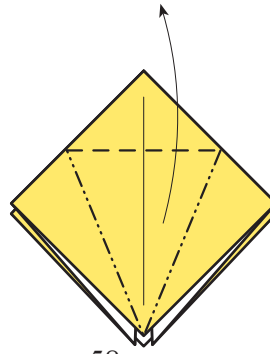

58.

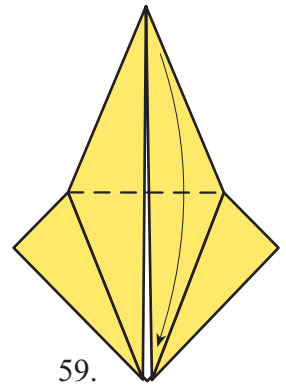

59.

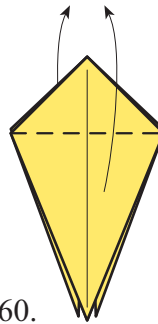

60.

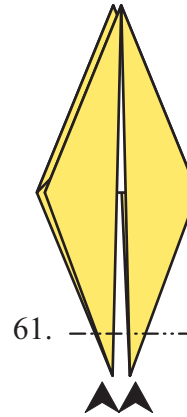

61.

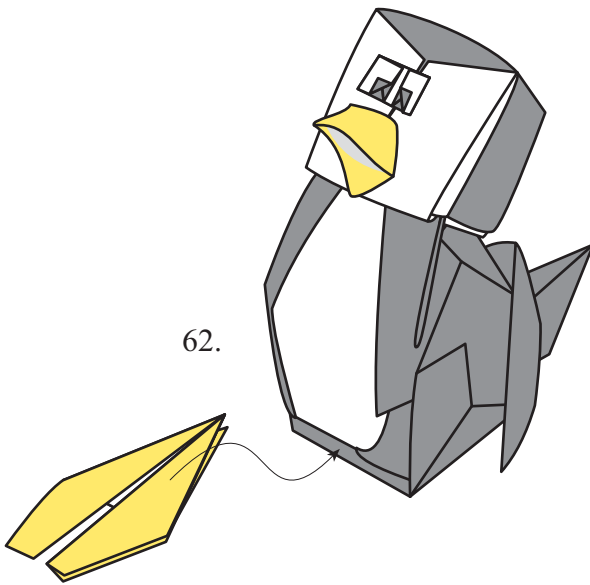

62.

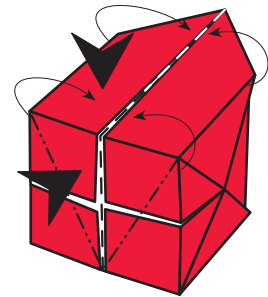

63. Empezar con una pieza igual a la del paso 36.

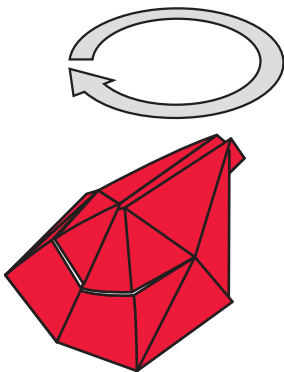

64.

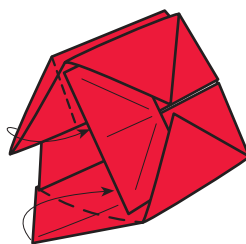

65.

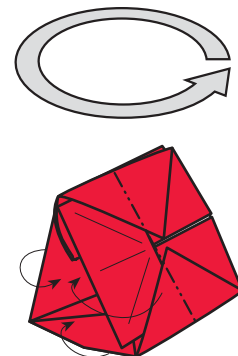

66.

PEGAMENTO

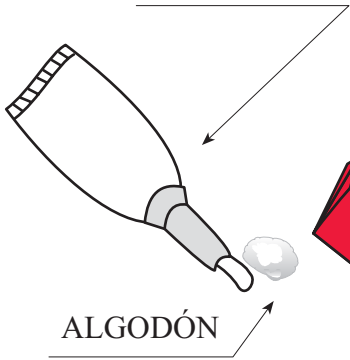

ALGODÓN

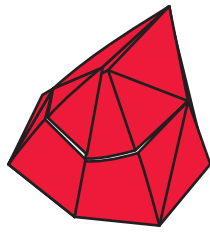

67.

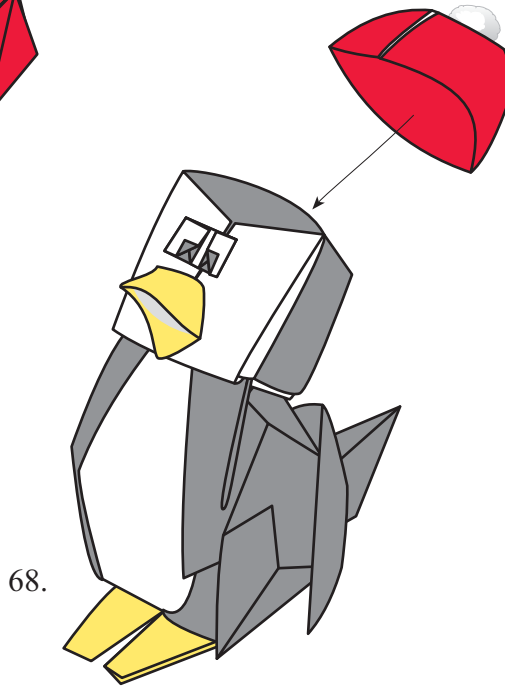

68.

