

Utilizando las medidas recomendadas, se obtiene un modelo final de 17 cms	
Autor:	Halle
Nivel de dificultad:	Medio-Alto
Número de piezas:	10
Forma de las piezas:	Cuadrados

Discover other models by Halle and download new diagrams at <http://design.origami.free.fr>

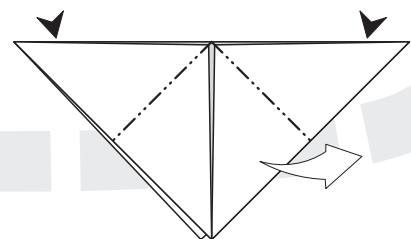

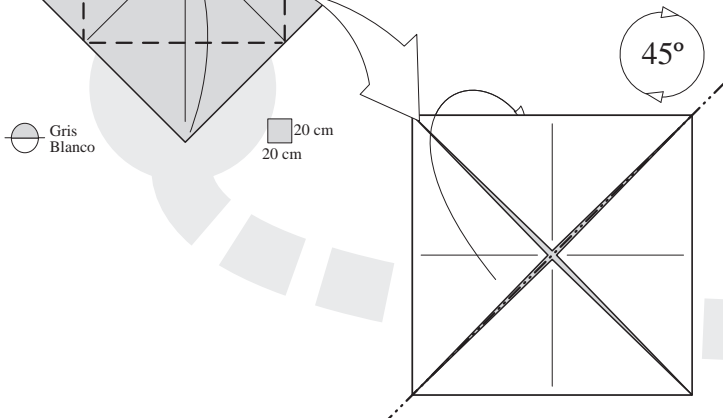
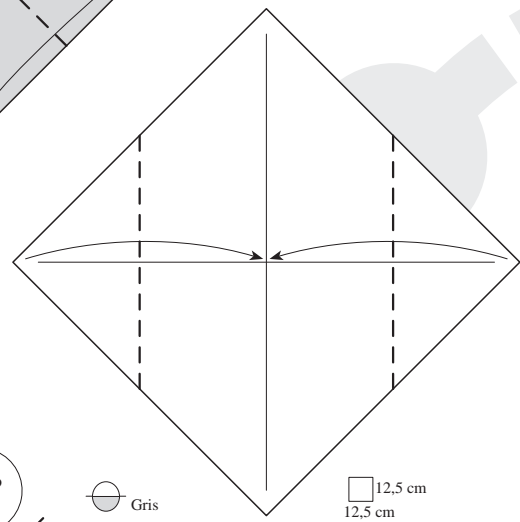
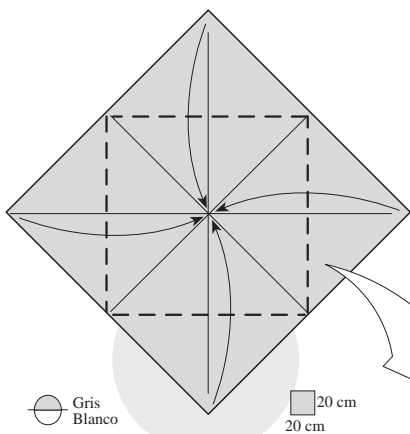
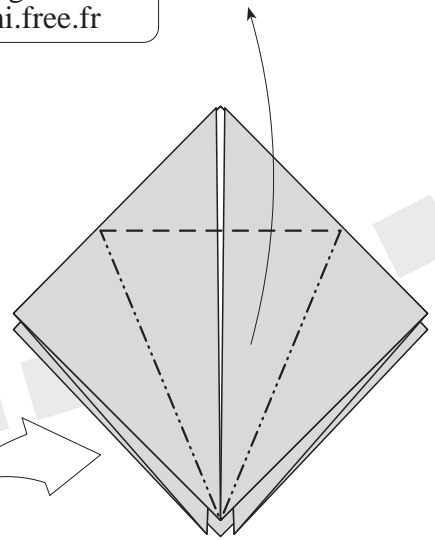
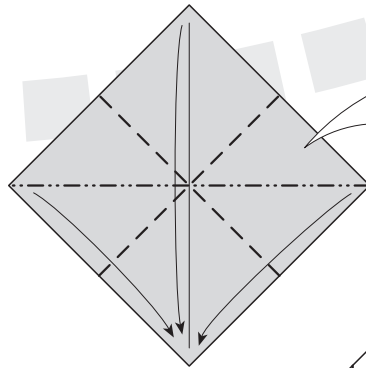
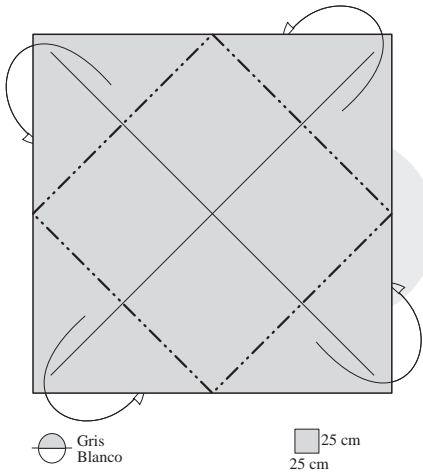
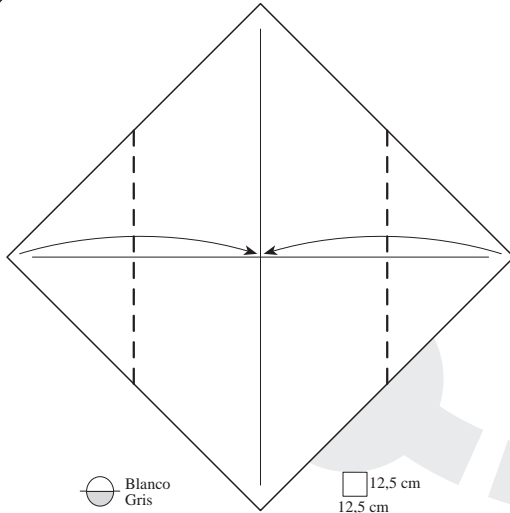
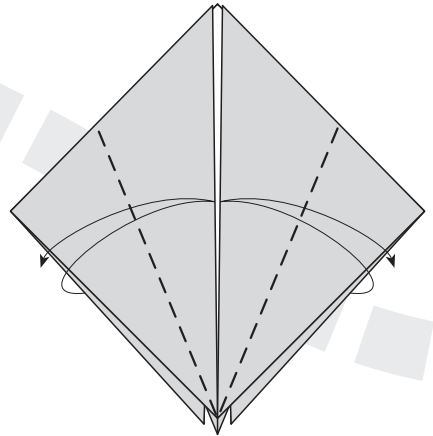
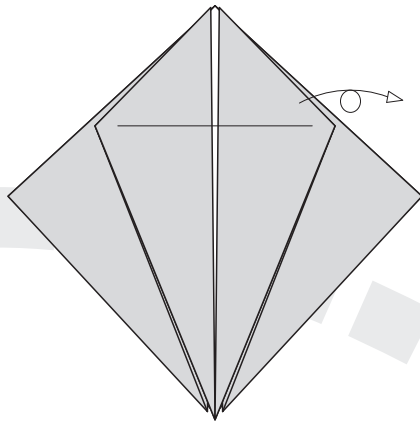
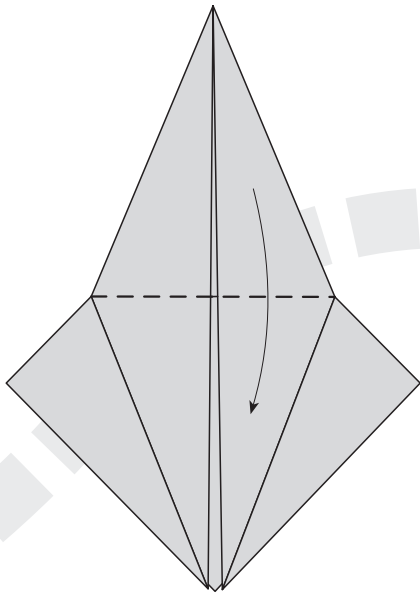

○ Blanco
○ Gris

□ 12,5 cm
□ 12,5 cm

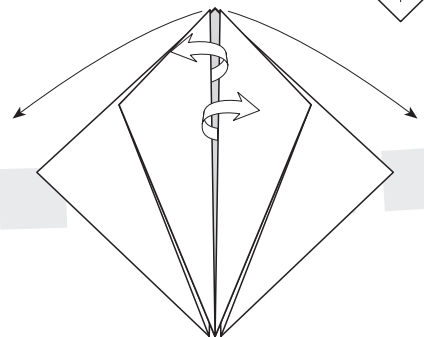
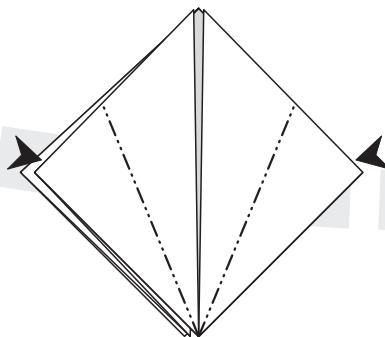
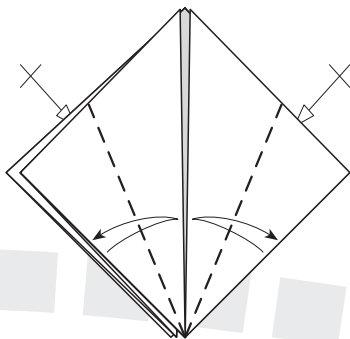
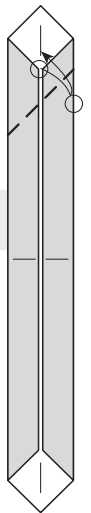
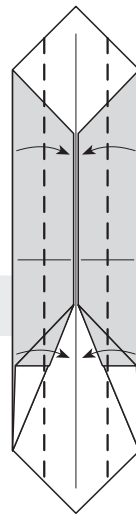
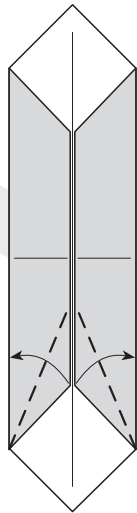
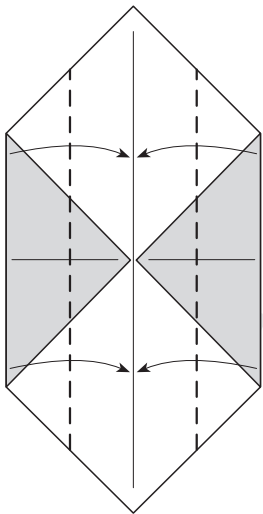
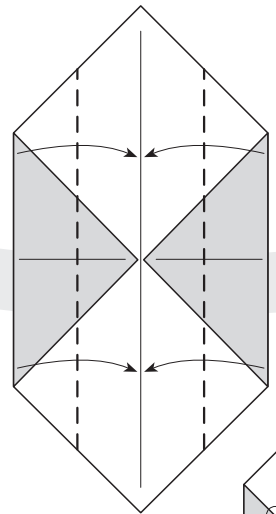

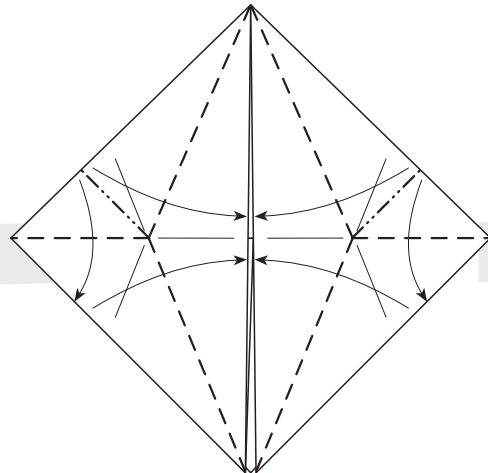
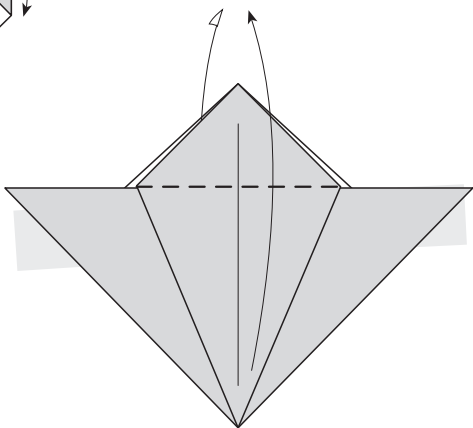
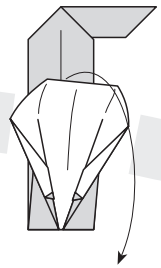
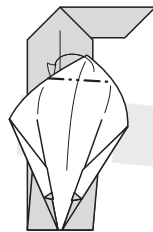
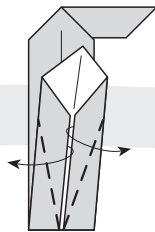
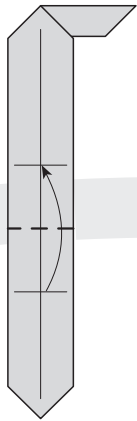
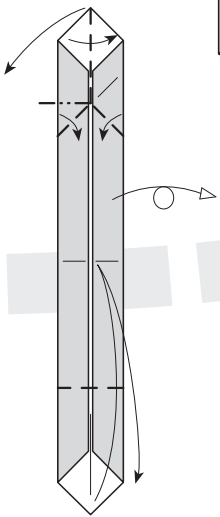
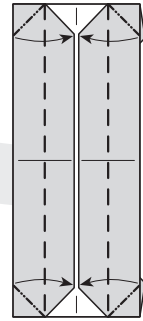
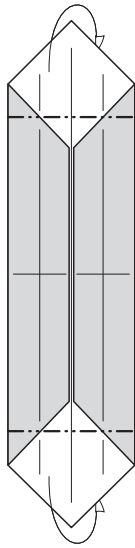
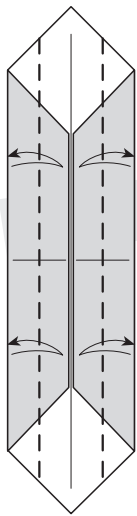
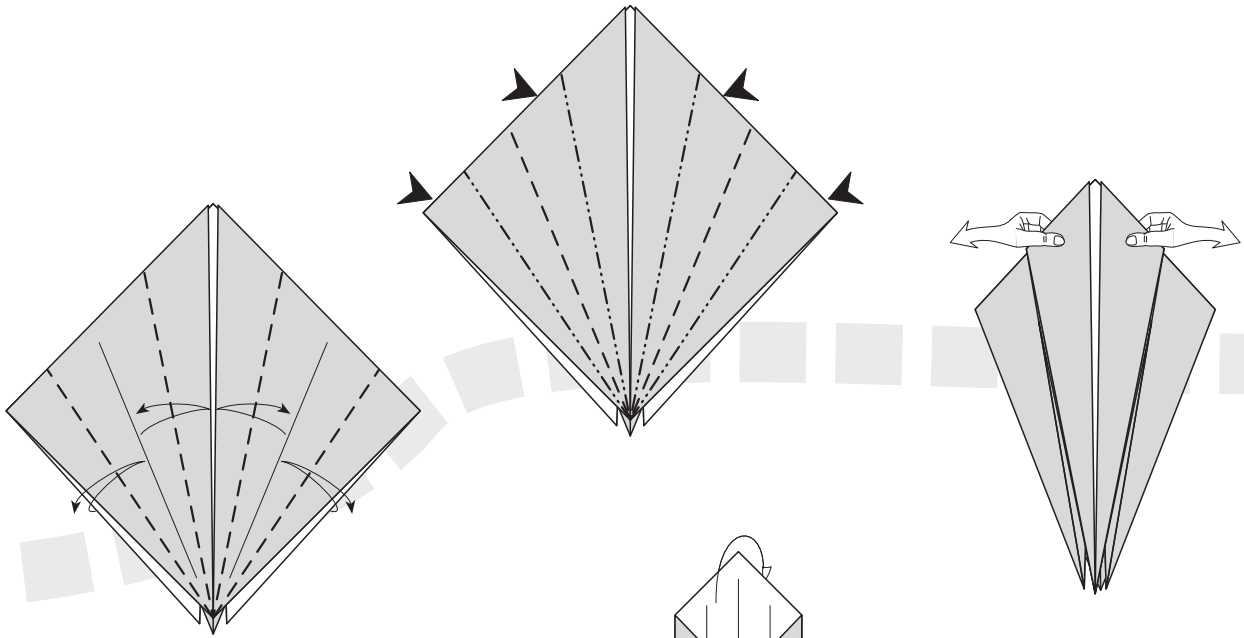

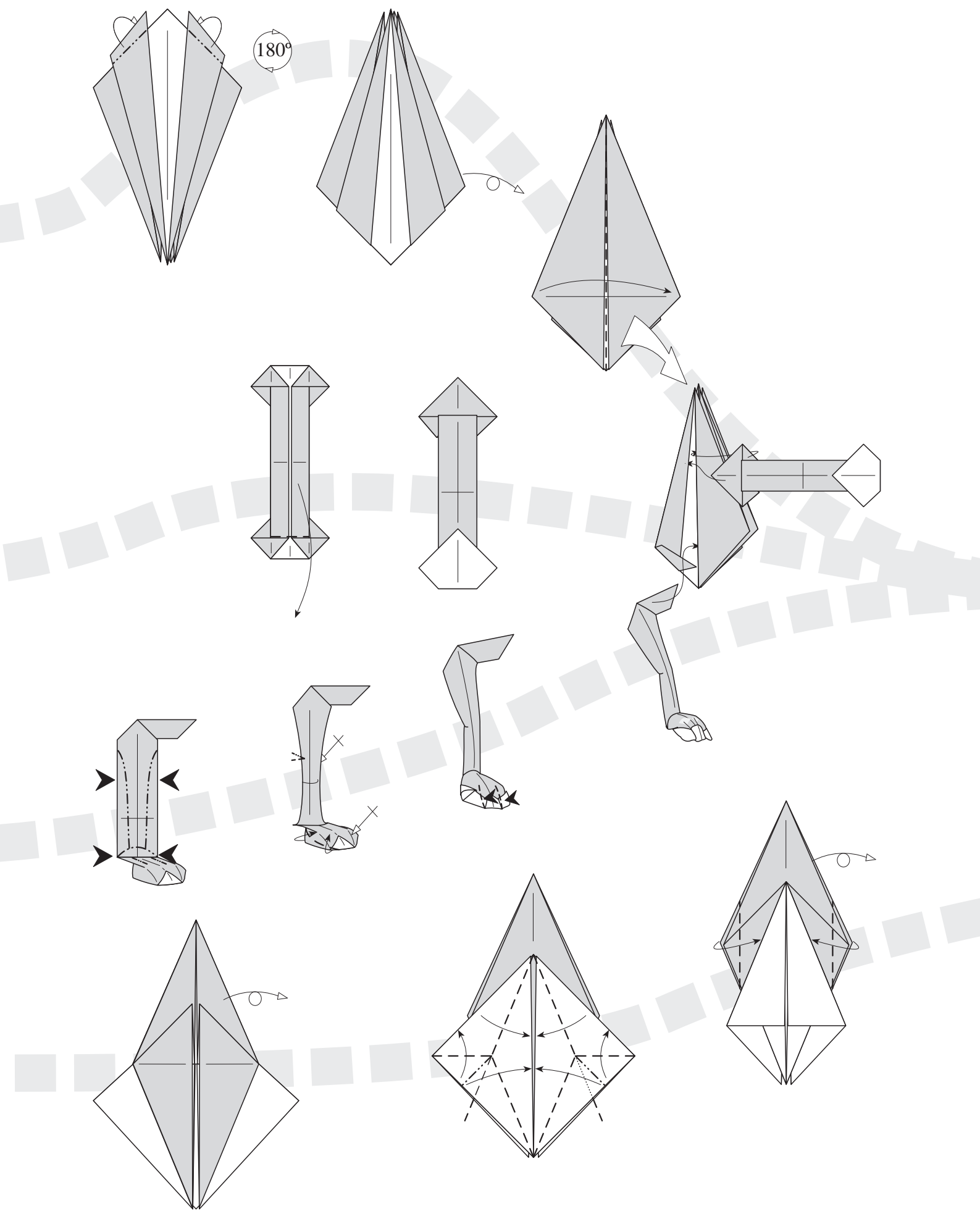

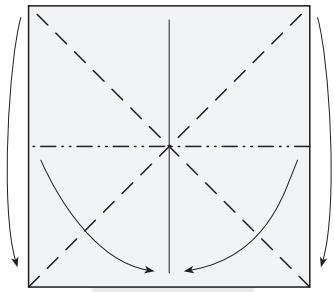

○ Blanco

□ 5 cm
5 cm

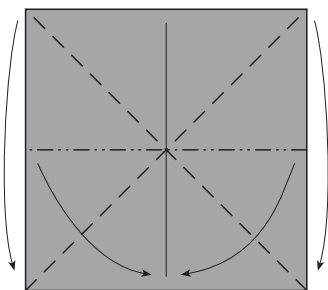
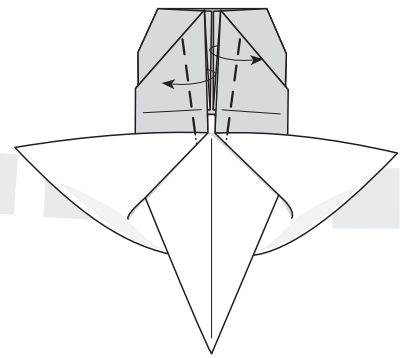
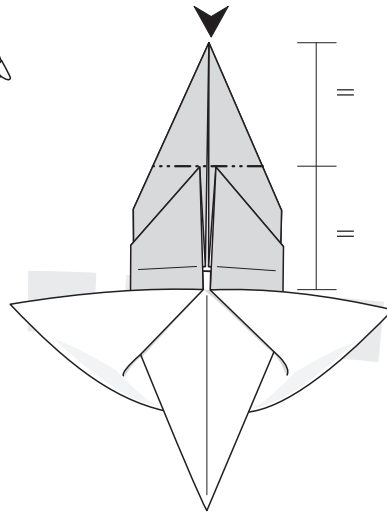
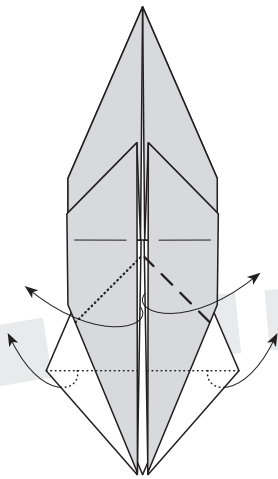
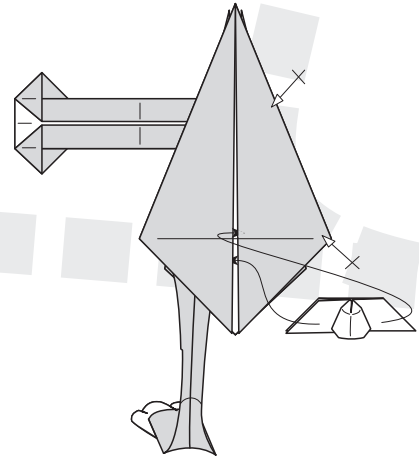
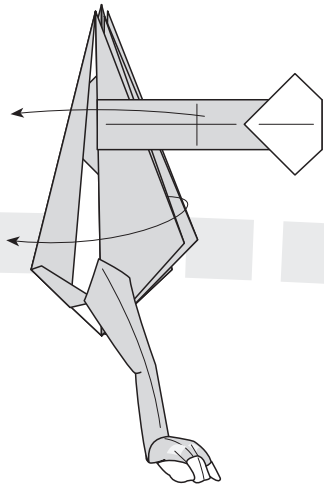
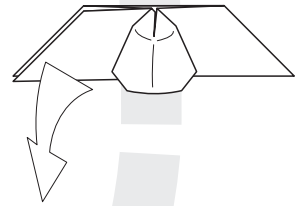
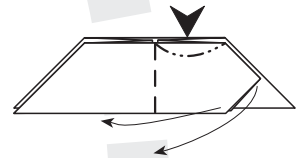
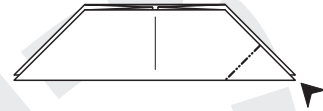
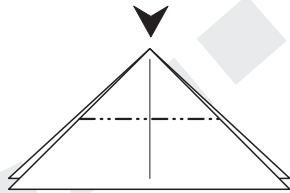
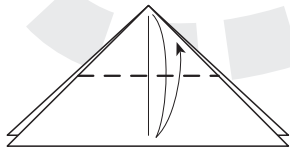

● Azul
○ Gris

□ 5 cm
5 cm

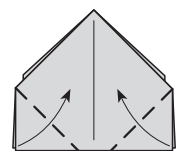
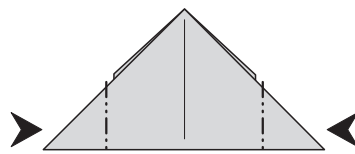
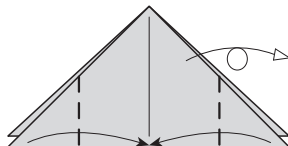

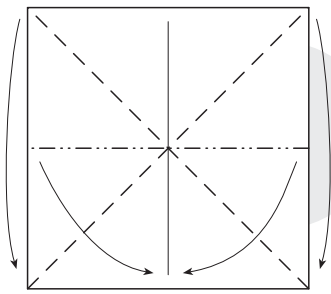

⊖ Rojo

□ 5 cm
5 cm

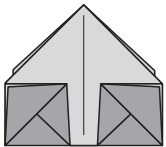
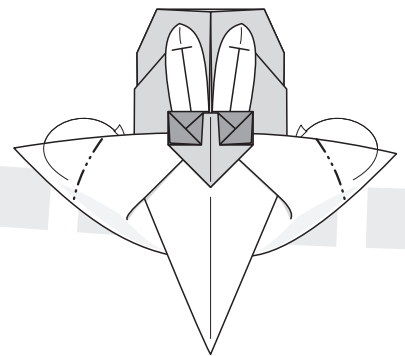
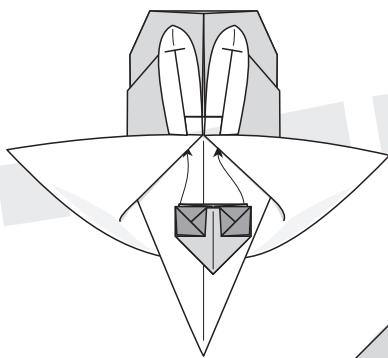
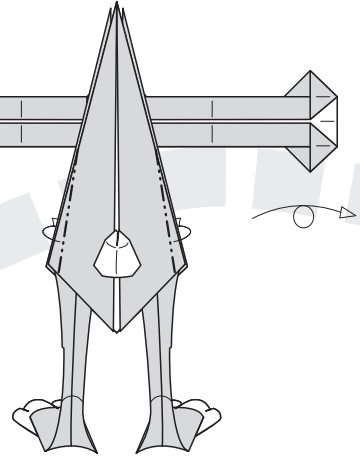
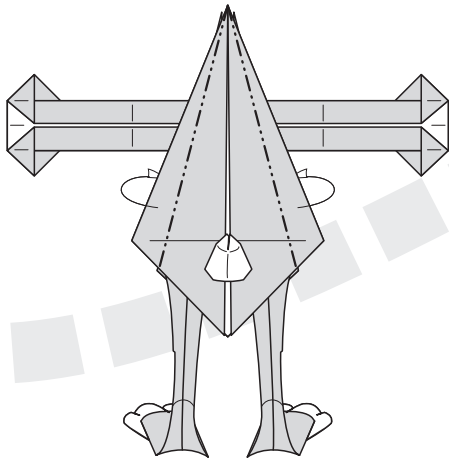
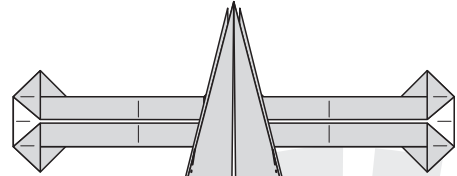
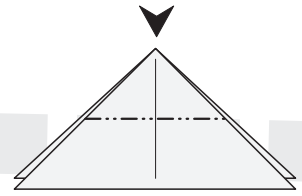
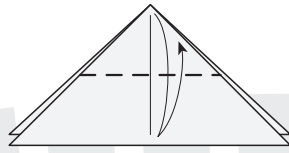

180°

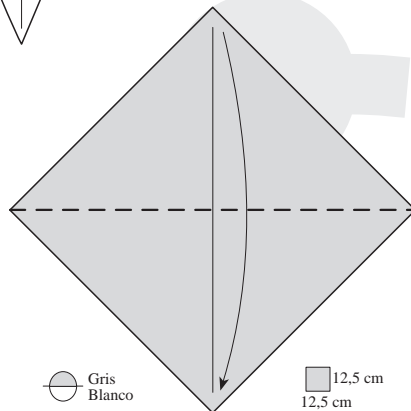
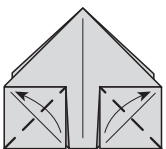

⊖ Gris
Blanco

□ 12,5 cm
12,5 cm

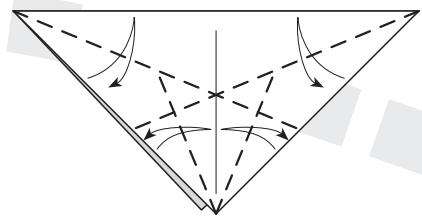

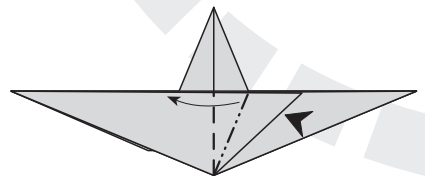
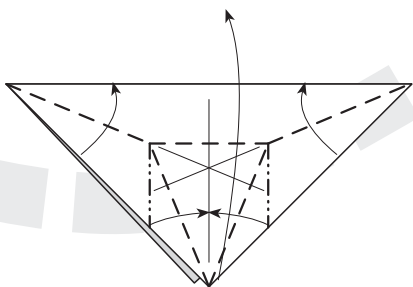
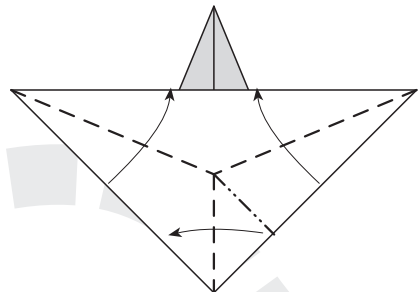
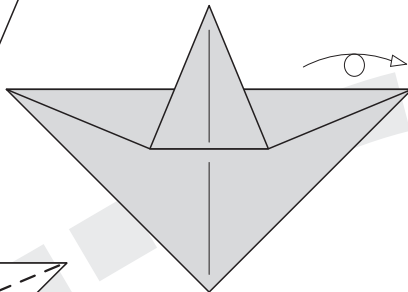
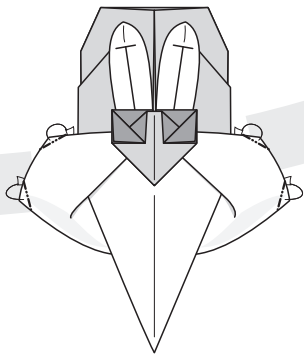
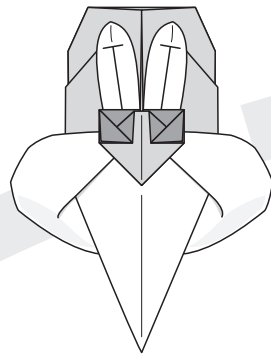
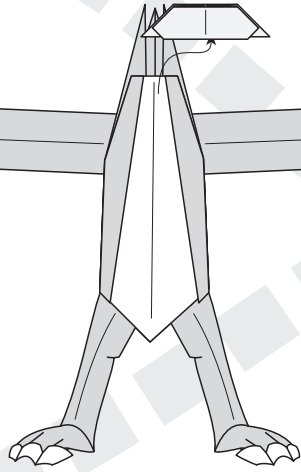
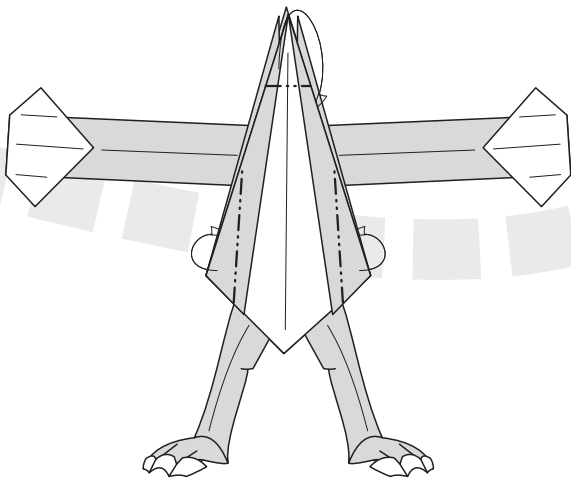
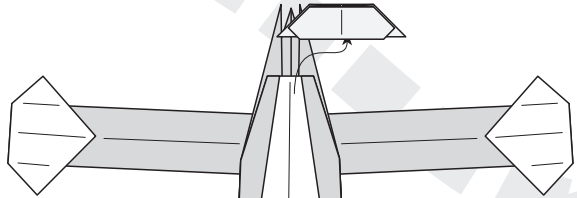

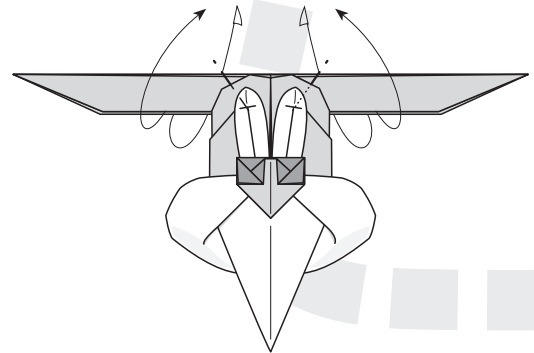
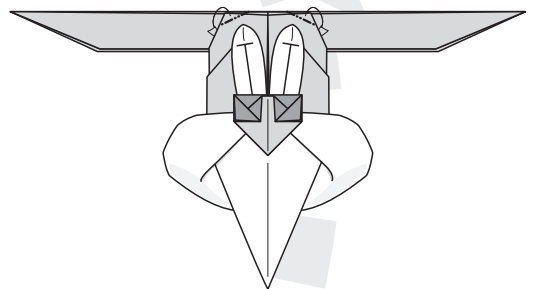
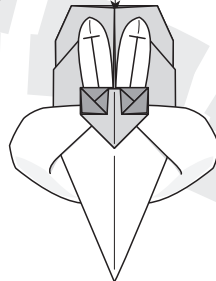
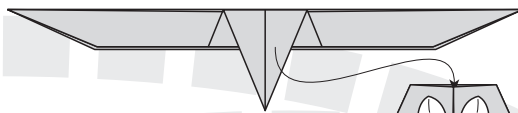
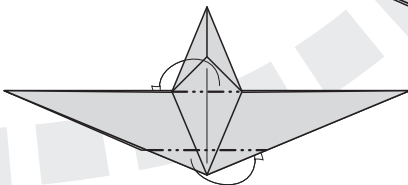
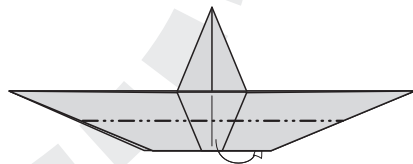
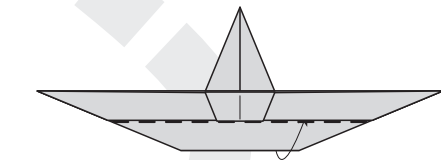
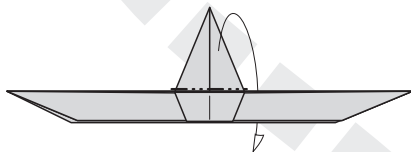
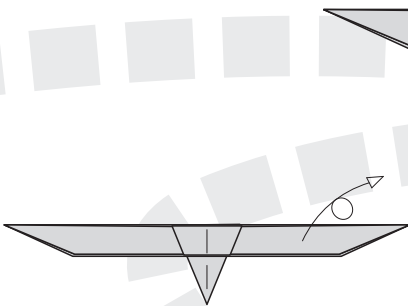
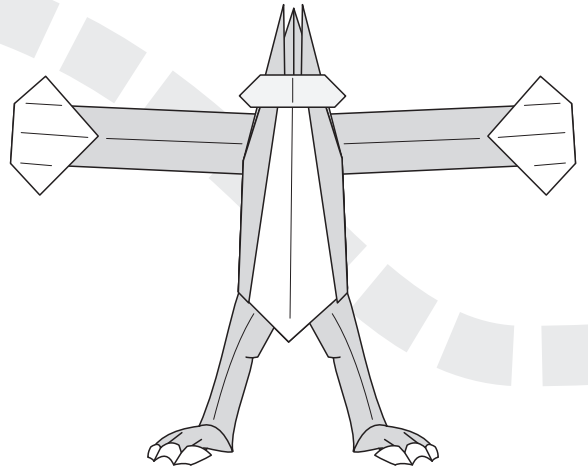
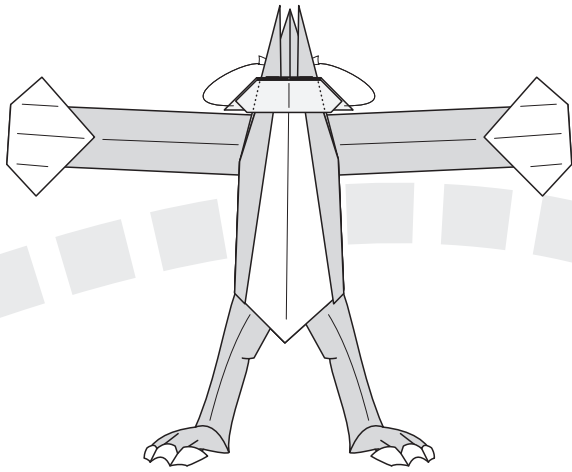

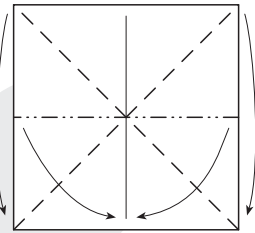
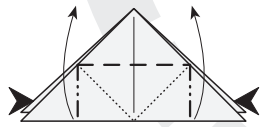
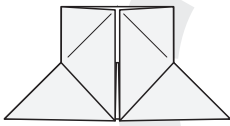
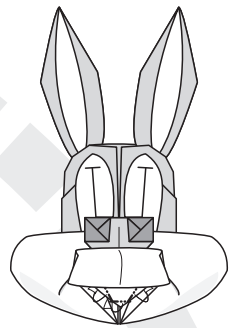
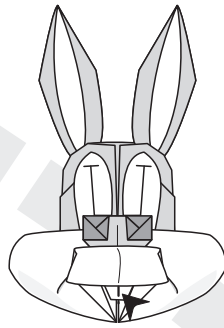
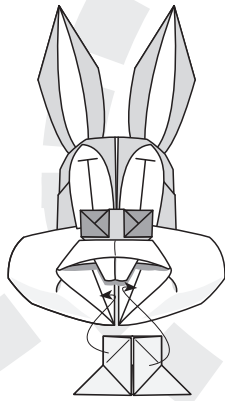
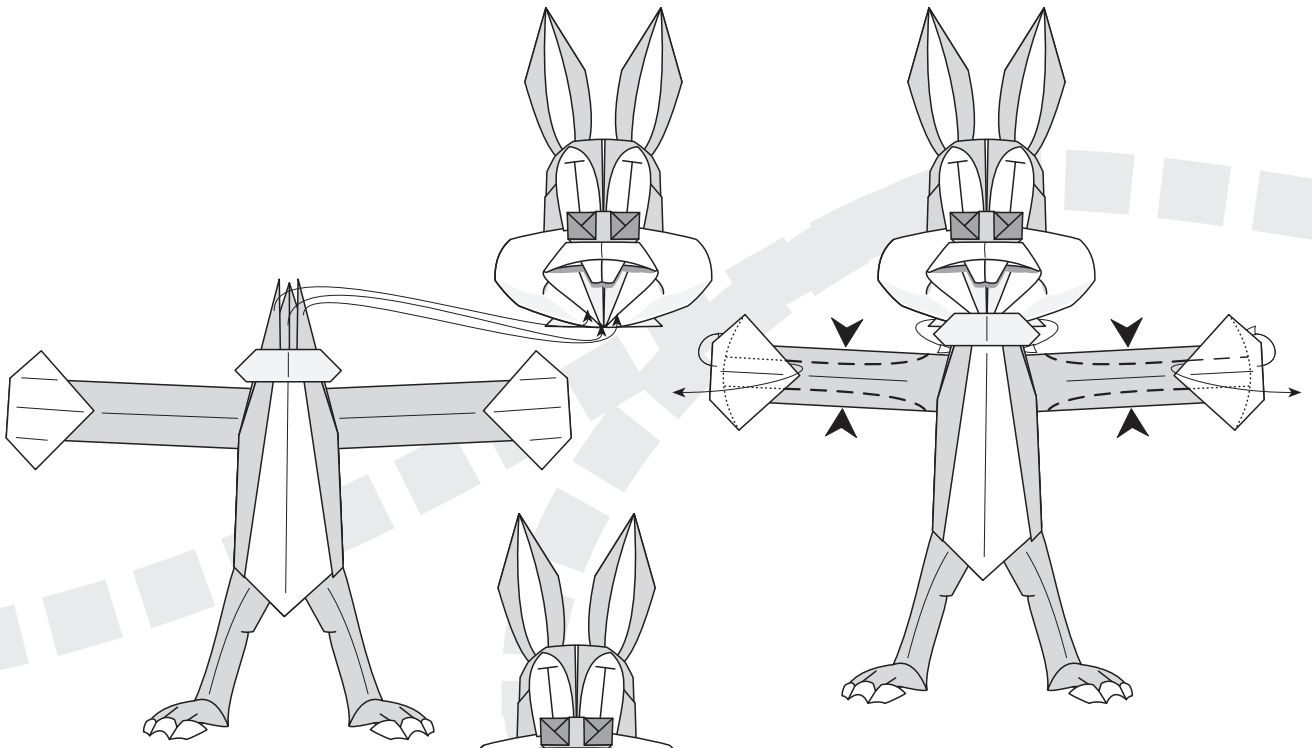

⊖ Rojo

5 cm
5 cm

